



Institute of Aeronautics and Applied Mechanics

Finite element method (FEM1)

Part 1. Introduction

The finite element method (FEM) is an approximate method which can be used as a numerical procedure to solve physical problems including:

- solid body mechanics,
- heat transfer,
- fluid flow,
- electromagnetism,
- coupled field problems
- ...

FEM was developed in 1950s to solve problems for the civil and aeronautical industries. The method became the most powerful analysis tool, mainly due to the development of computers.

The aim of the lecture is to supply basic knowledge and skills required for understanding and application of the FEM to solve boundary value problems for partial differential equations (PDEs).

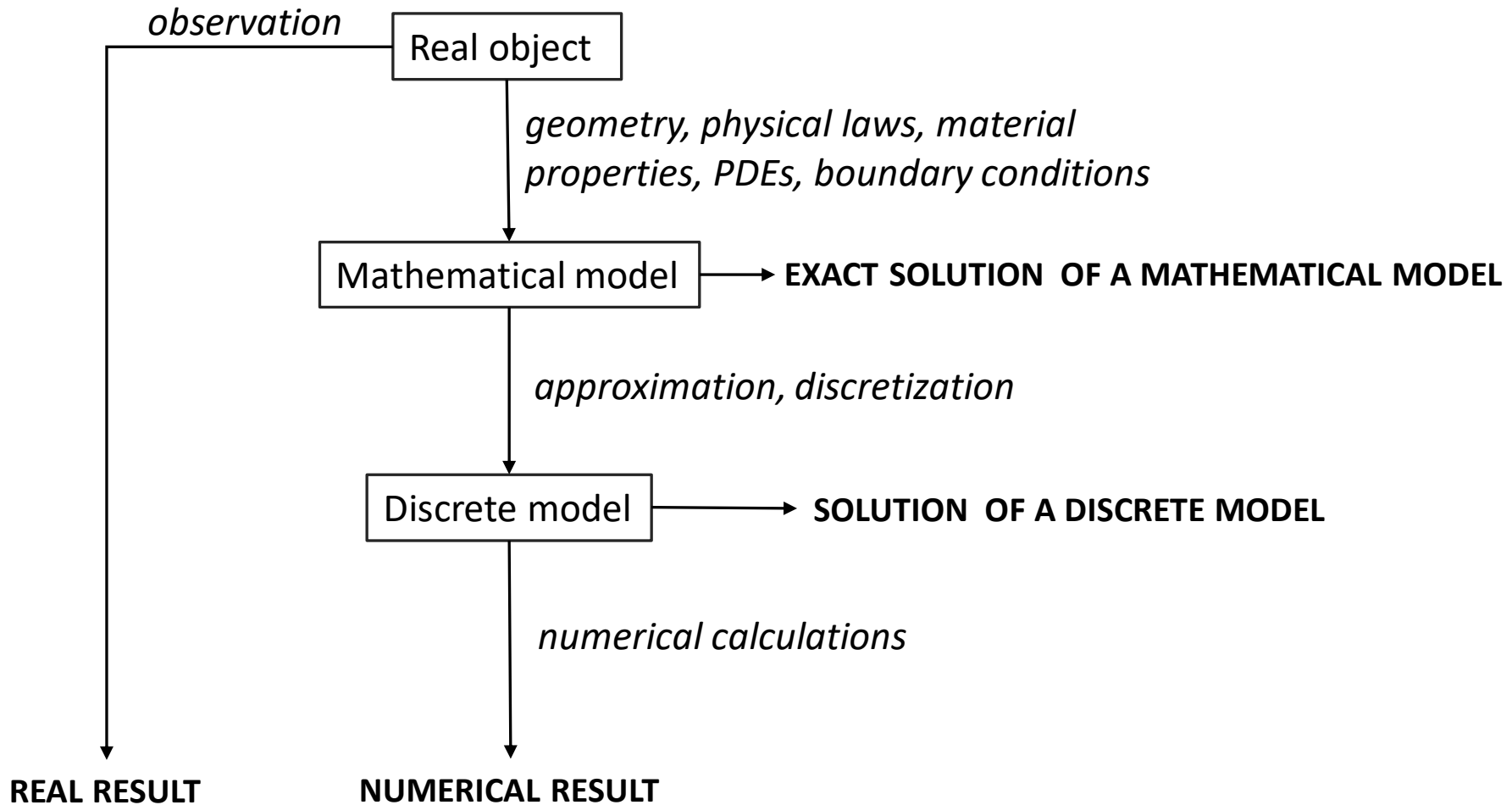

Errors

total error = modelling error + discretization error + numerical error

modelling error \approx discretization error \approx numerical error \rightarrow min

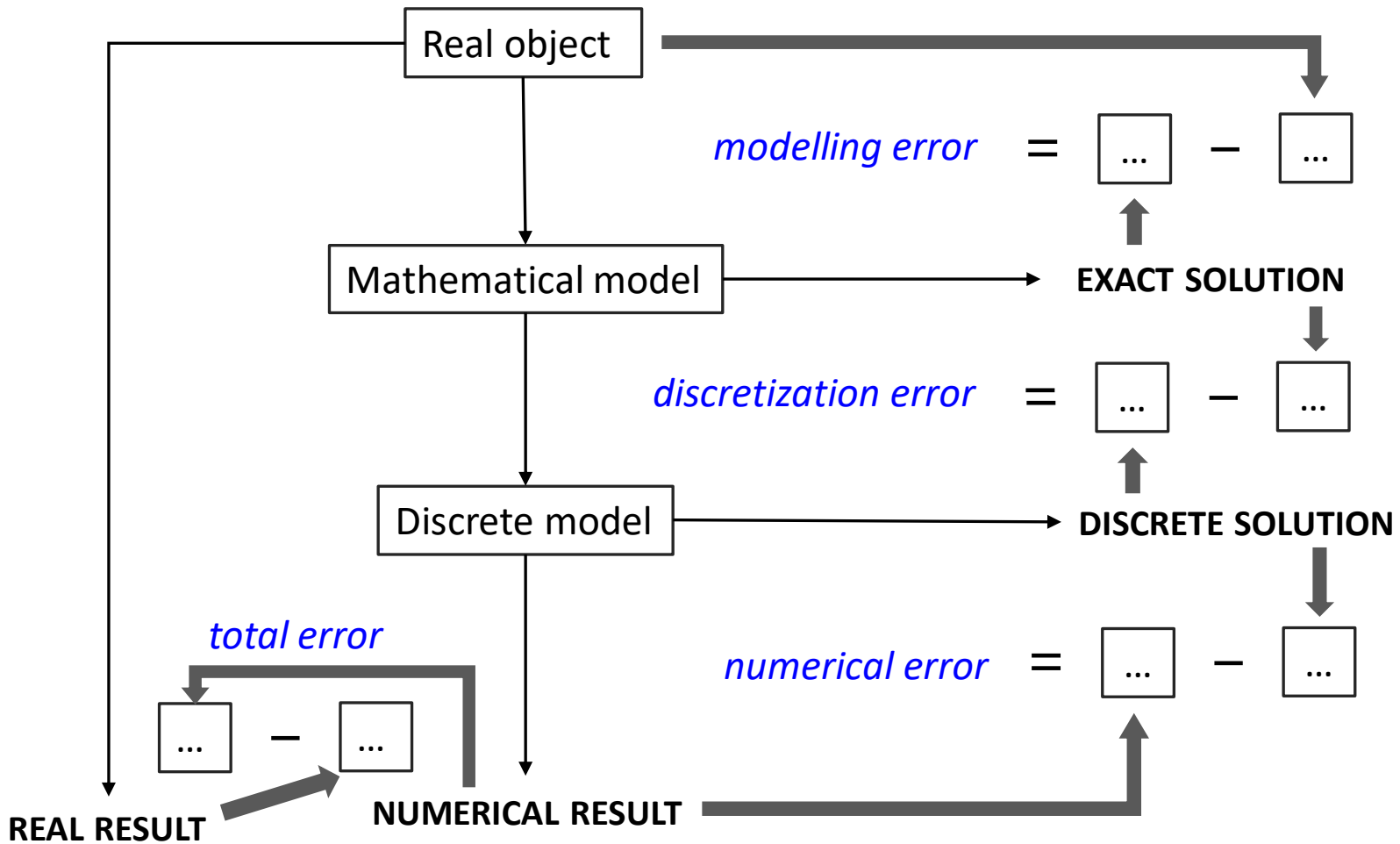

Example. Wooden board loaded by gravity

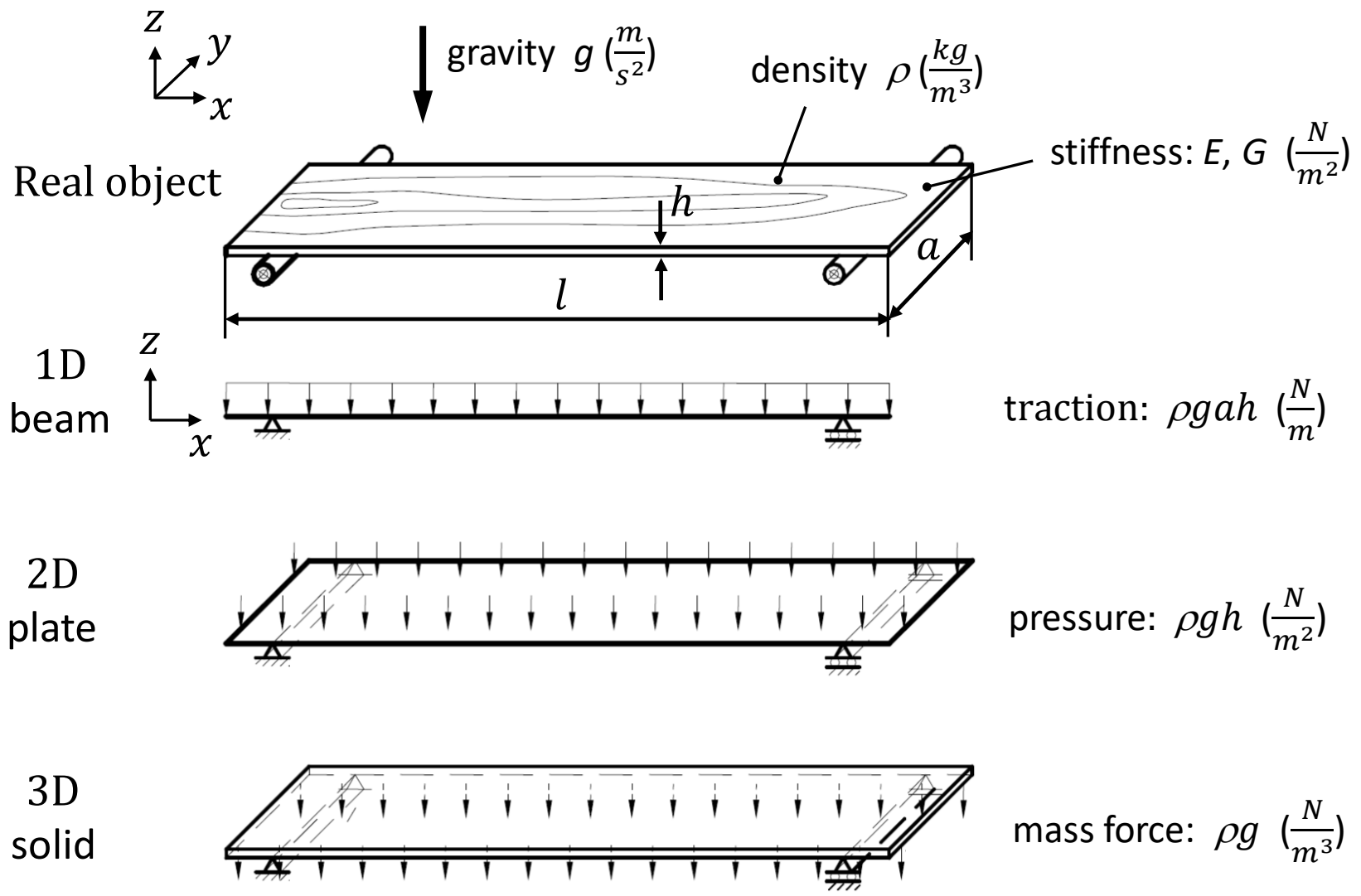

Example. Wooden board loaded by gravity

Discrete model versus mathematical model

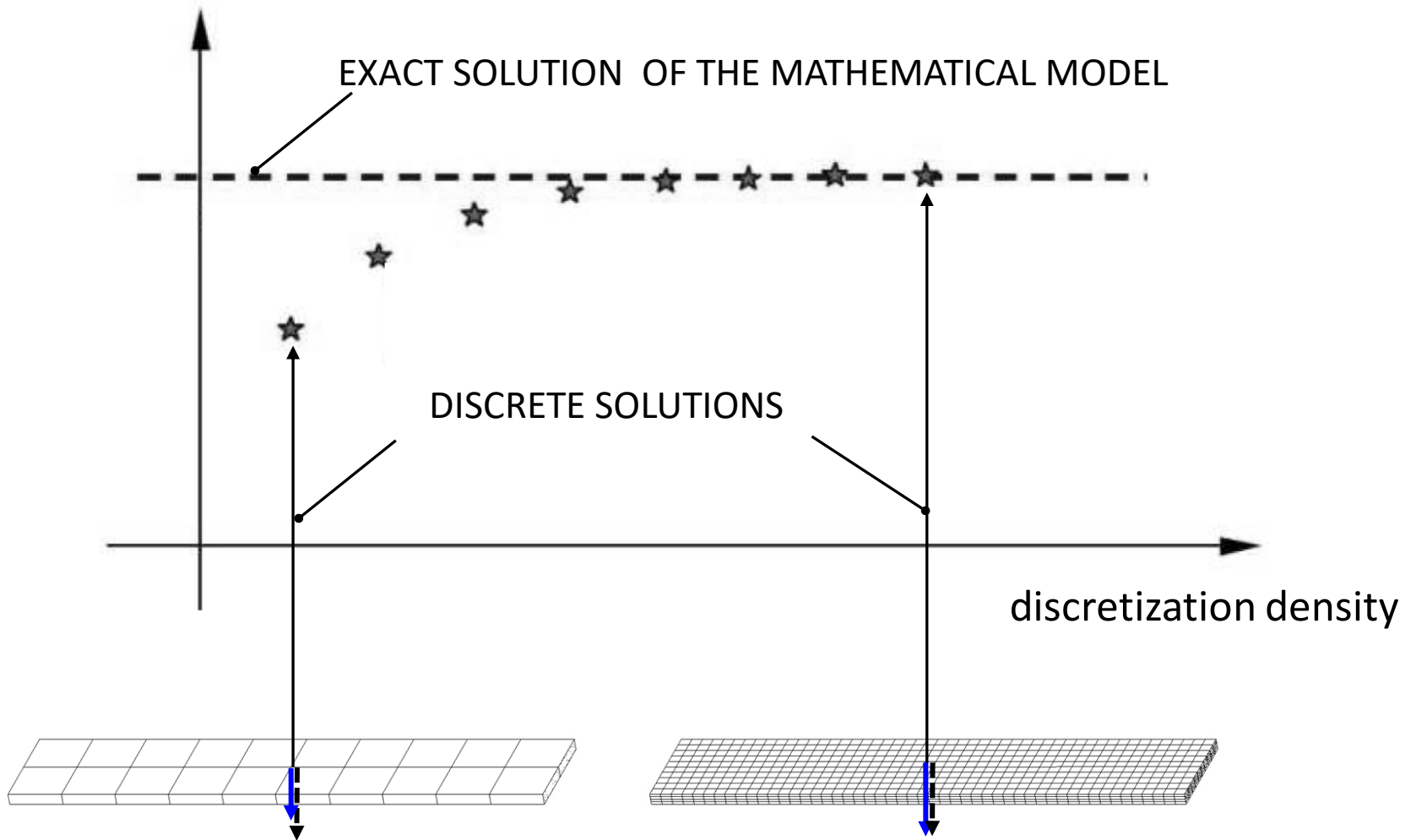

FE modeling – basic steps

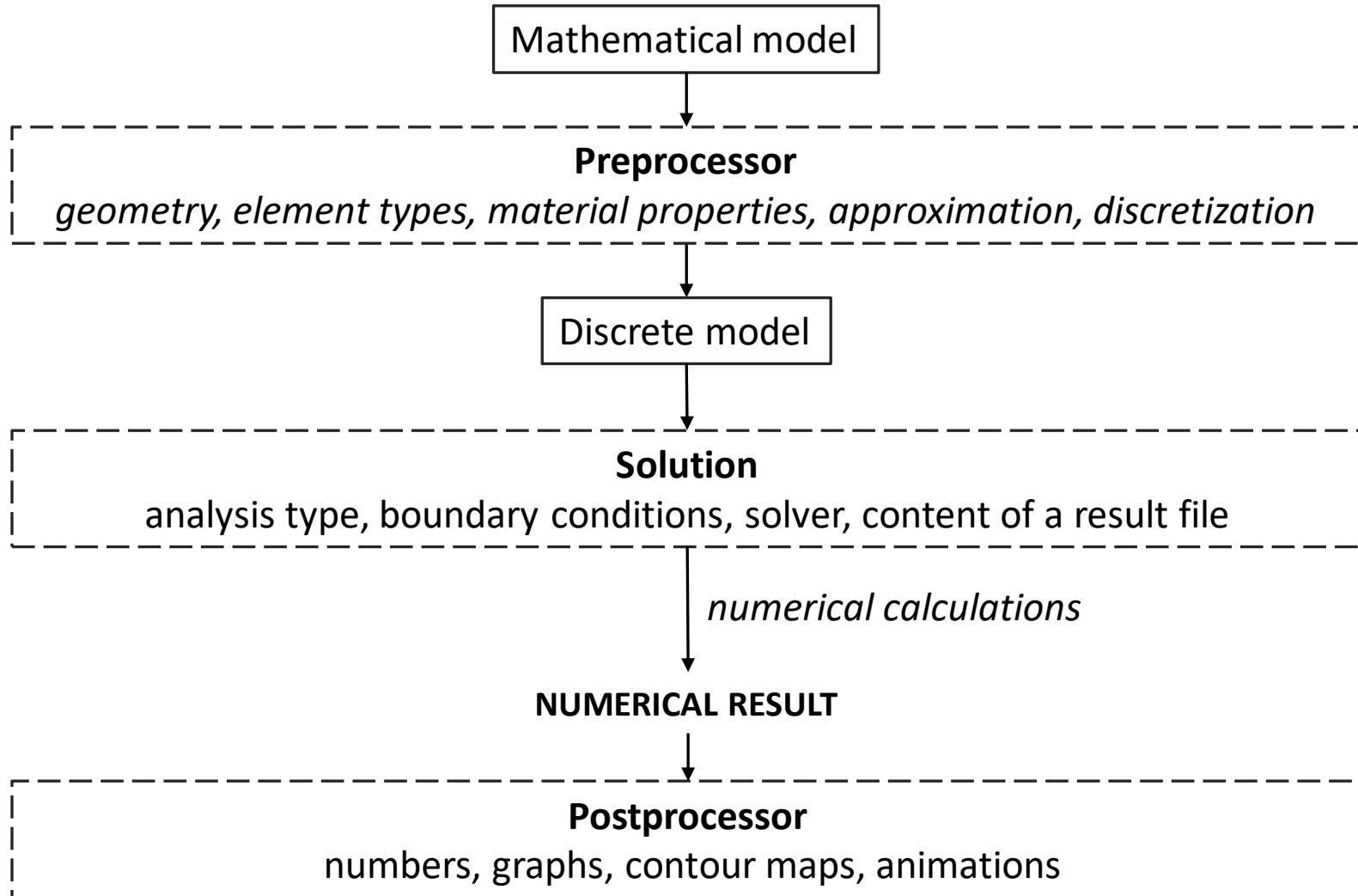

Boundary value problem of solid body mechanics

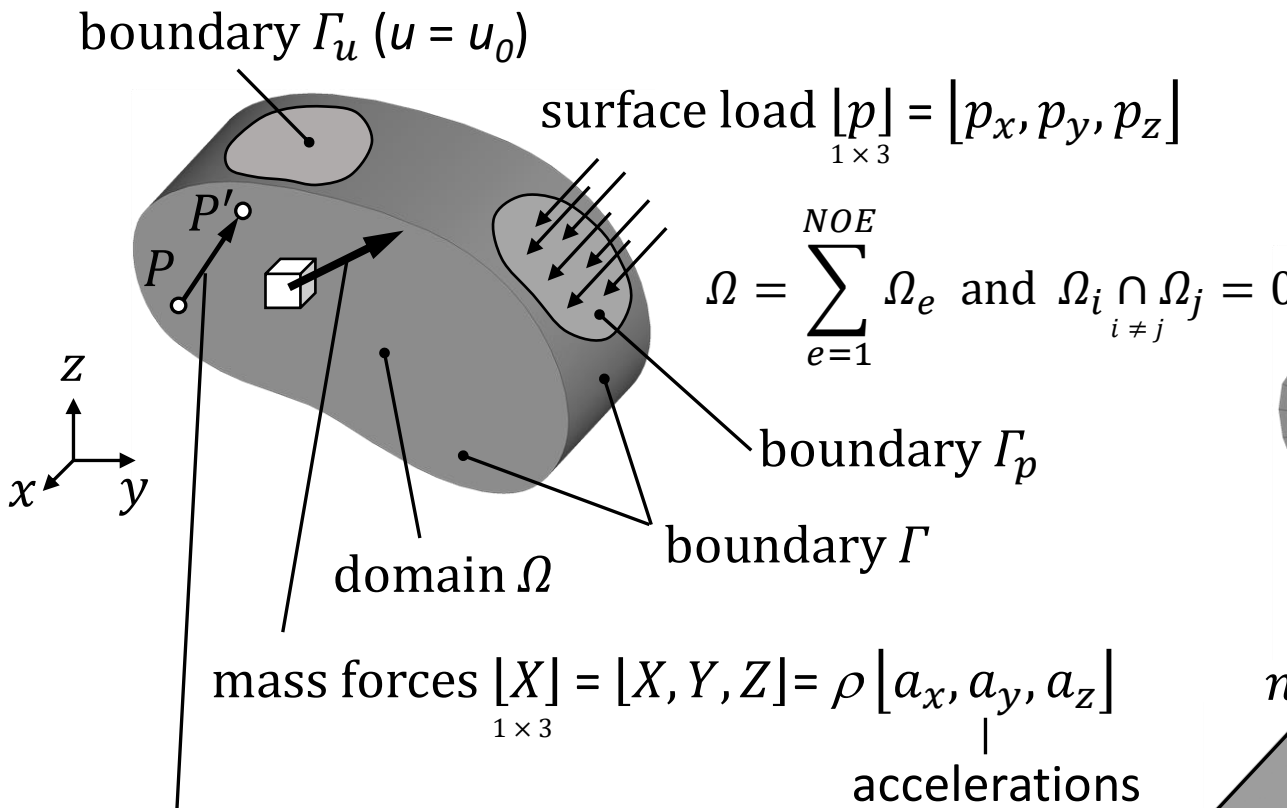

FE model

NOE – no. of FEs
NON – no. of nodes

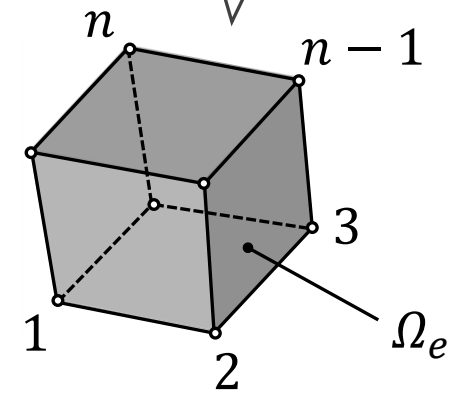
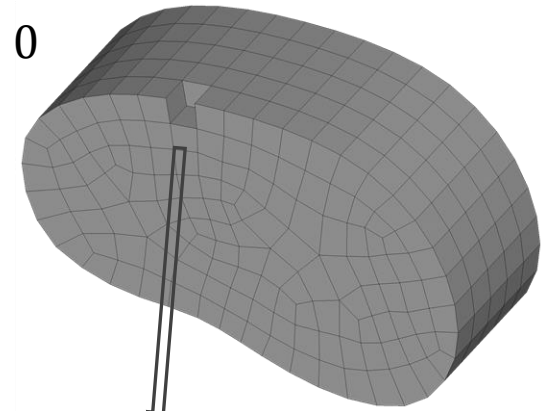

Finite element with n - nodes

UNKNOWN FUNCTION

displacement vector $\{u\} = \begin{Bmatrix} u(x, y, z) \\ v(x, y, z) \\ w(x, y, z) \end{Bmatrix}$
 3×1

Nodal approximation inside the finite element with n - nodes

$$\text{displacement vector } \{u\} = [N(\xi, \eta, \zeta)] \{q\}_e$$

3×1 $3 \times n_e$ $n_e \times 1$

$[N(\xi, \eta, \zeta)]$ – matrix of shape functions
 $3 \times n_e$

$$n_e = n \cdot n_p$$

n_e – no. of degrees of freedom in FE

n_p – no. of degrees of freedom per node

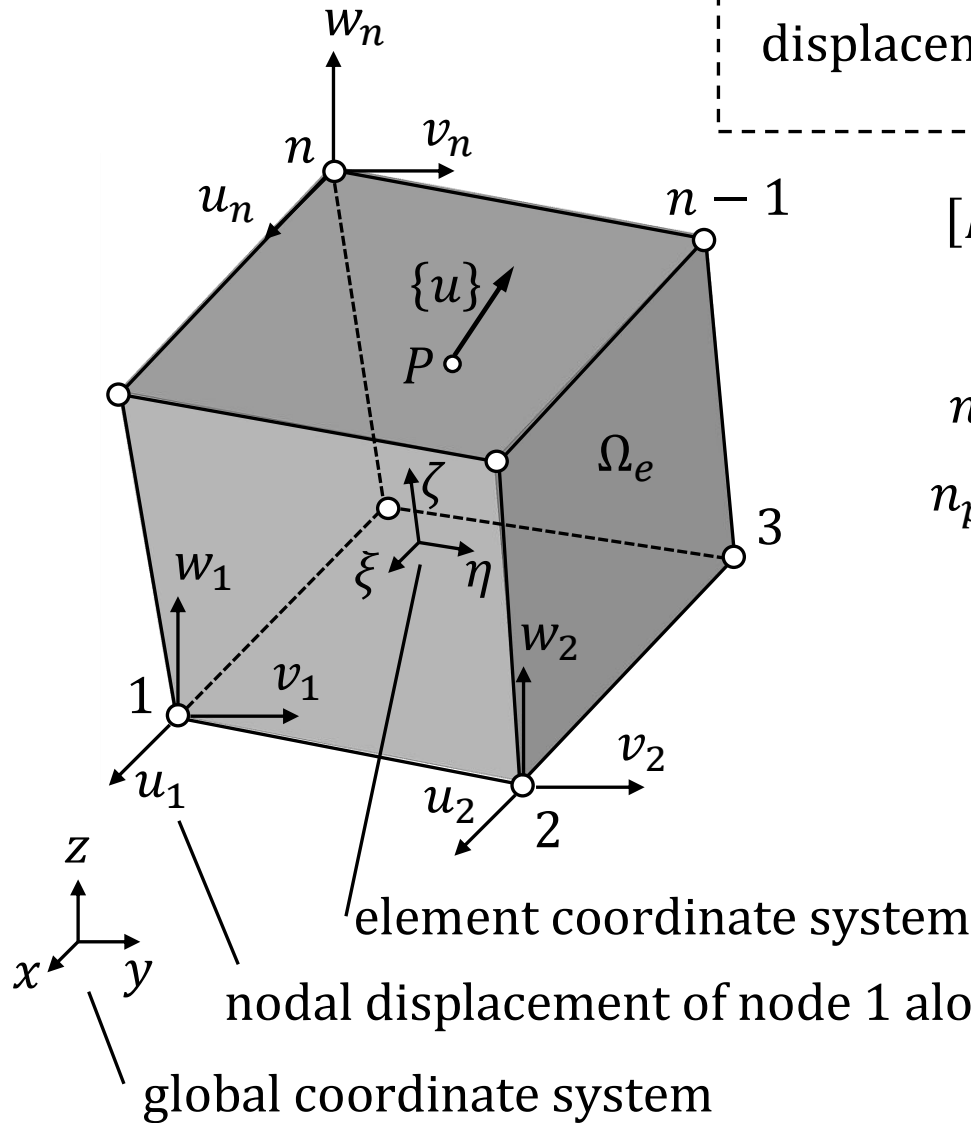

$$\{q\}_e = \begin{Bmatrix} u_1 \\ v_1 \\ w_1 \\ \vdots \\ u_n \\ v_n \\ w_n \end{Bmatrix}_e$$

– local vector of nodal parameters

Matrix of shape functions

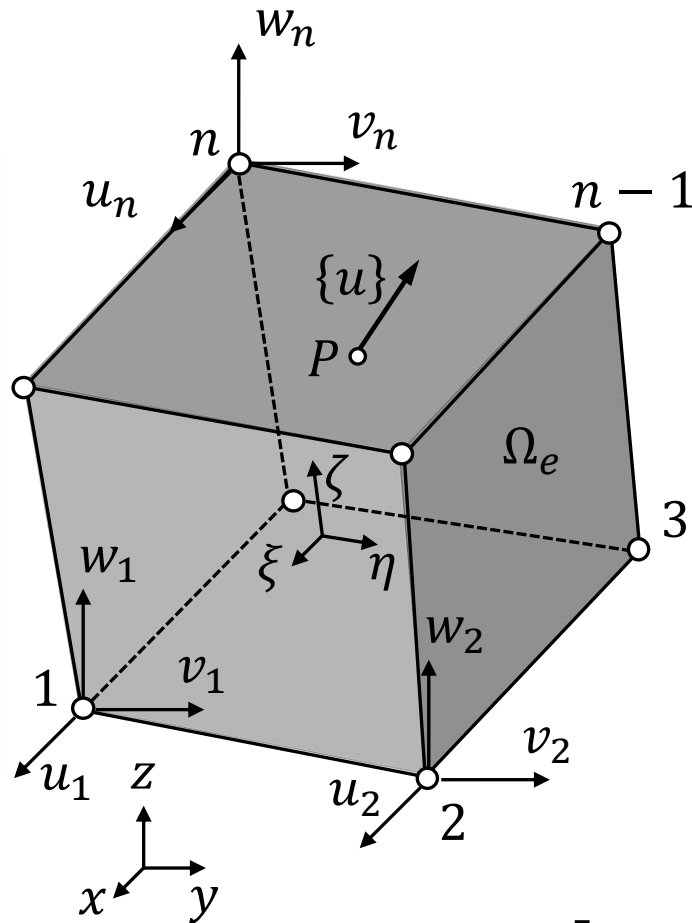

Nodal approximation:

$$\{u\} = [N(\xi, \eta, \zeta)] \{q\}_e$$

3×1 $3 \times n_e$ $n_e \times 1$

$$u = N_1 \cdot u_1 + N_2 \cdot u_2 + \dots + N_n \cdot u_n$$

$$v = N_1 \cdot v_1 + N_2 \cdot v_2 + \dots + N_n \cdot v_n$$

$$w = N_1 \cdot w_1 + N_2 \cdot w_2 + \dots + N_n \cdot w_n$$

$$\{q\}_e = \begin{Bmatrix} u_1 \\ v_1 \\ w_1 \\ \vdots \\ u_n \\ v_n \\ w_n \end{Bmatrix}_e$$

$n_e \times 1$

$$[N(\xi, \eta, \zeta)] = \begin{bmatrix} N_1 & 0 & 0 & N_2 & 0 & 0 & N_n & 0 & 0 \\ 0 & N_1 & 0 & 0 & N_2 & 0 & \dots & 0 & N_n \\ 0 & 0 & N_1 & 0 & 0 & N_2 & 0 & 0 & N_n \end{bmatrix}$$

$3 \times n_e$

Examples of finite elements

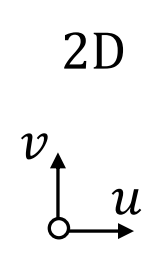
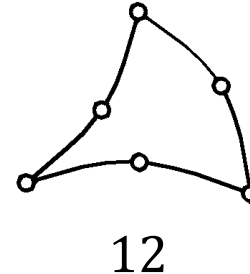
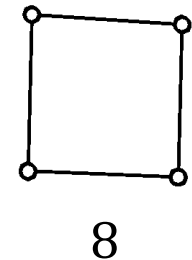
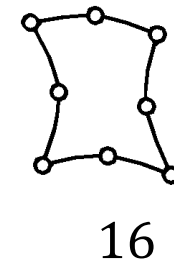
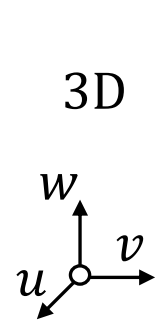
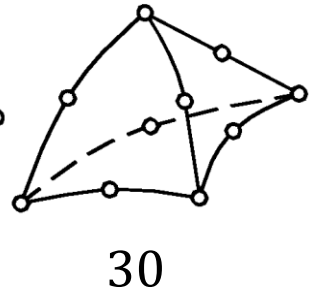
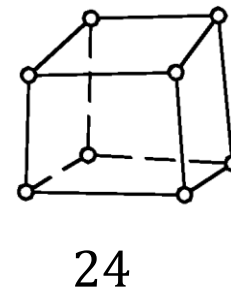
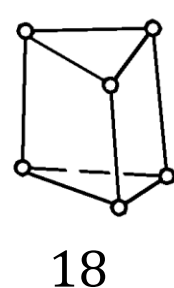
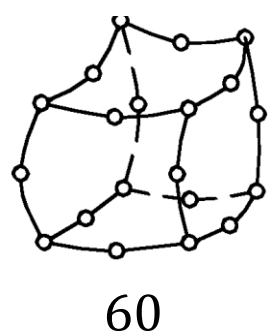
Type	n_e – number of degrees of freedom in FE				
rods					
2D					
3D					

Example: shape functions for a finite element representing a strut

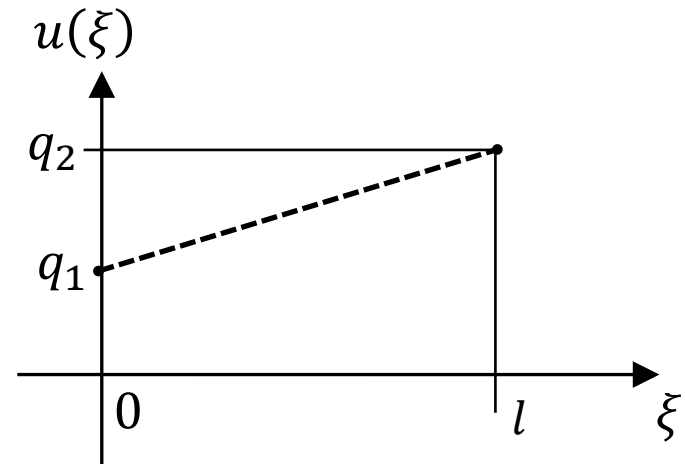
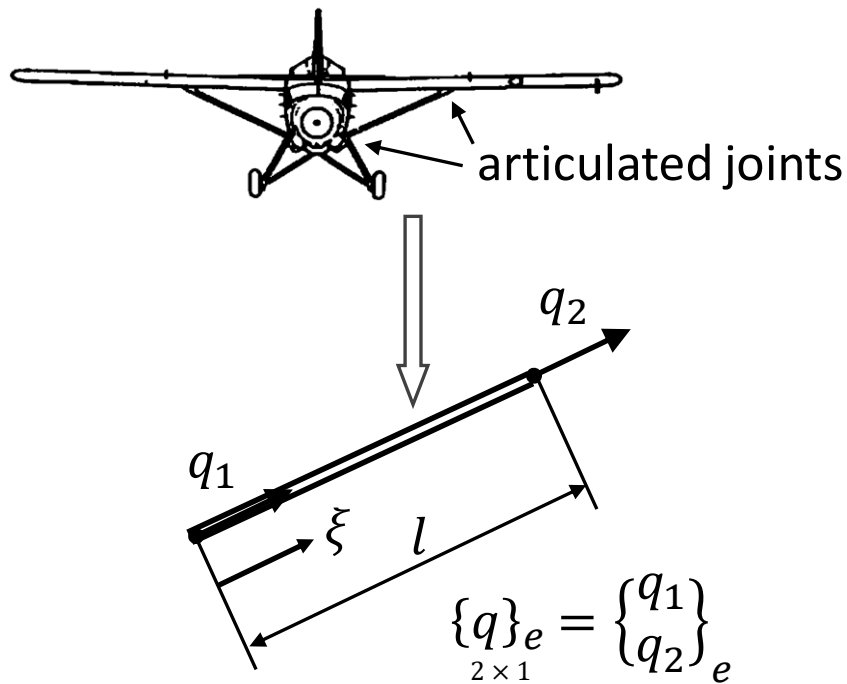

a linear function:

$$u(\xi) = \frac{q_2 - q_1}{l} \xi + q_1$$

$$u(\xi) = \frac{q_2 - q_1}{l} \xi + q_1 = \frac{q_2}{l} \xi - \frac{q_1}{l} \xi + q_1 = \left(1 - \frac{\xi}{l}\right) q_1 + \frac{\xi}{l} q_2 =$$

$$N_1(\xi) \cdot q_1 + N_2(\xi) \cdot q_2 = [N_1, N_2] \begin{Bmatrix} q_1 \\ q_2 \end{Bmatrix}_e = [N(\xi)] \{q\}_e$$

$1 \times 2 \quad 2 \times 1$

shape functions: $N_1(\xi) = 1 - \frac{\xi}{l}$; $N_2(\xi) = \frac{\xi}{l}$

Strain components

normal strains:

$$\epsilon_x = \frac{(A'B')_x - AB}{AB} = \frac{(dx + u + \frac{\partial u}{\partial x} dx - u) - dx}{dx} = \frac{\partial u}{\partial x}$$

$$\epsilon_y = \frac{\partial v}{\partial y} \quad ; \quad \epsilon_z = \frac{\partial w}{\partial z}$$

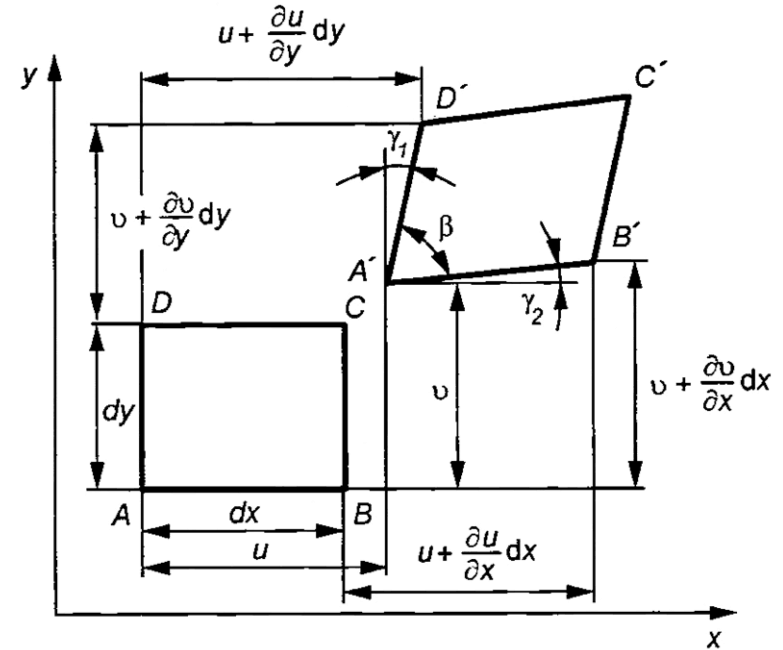

shear strains:

$$\gamma_{xy} = \frac{\pi}{2} - \beta = \gamma_1 + \gamma_2$$

$$\gamma_1 \cong \tan \gamma_1 = \frac{(A'D')_x}{(A'D')_y} = \frac{u + \frac{\partial u}{\partial y} dy - u}{dy + v + \frac{\partial v}{\partial y} dy - v} = \frac{\frac{\partial u}{\partial y}}{1 + \frac{\partial v}{\partial y}} = \frac{\frac{\partial u}{\partial y}}{1 + \epsilon_y} = \frac{\partial u}{\partial y}$$

$$\gamma_2 \cong \frac{\partial v}{\partial x} \quad \rightarrow \quad \gamma_{xy} = \frac{\partial u}{\partial y} + \frac{\partial v}{\partial x}$$

small deformations: $\epsilon_y \ll 1$

$$\gamma_{yz} = \frac{\partial v}{\partial z} + \frac{\partial w}{\partial y} \quad ; \quad \gamma_{zx} = \frac{\partial w}{\partial x} + \frac{\partial u}{\partial z} \quad ; \quad \gamma_{ij} = \gamma_{ji}$$

Strain tensor. Vector of strain components

strain tensor:

$$\boldsymbol{\varepsilon} = \begin{bmatrix} \varepsilon_x & \gamma_{xy}/2 & \gamma_{xz}/2 \\ \gamma_{yx}/2 & \varepsilon_y & \gamma_{yz}/2 \\ \gamma_{zx}/2 & \gamma_{zy}/2 & \varepsilon_z \end{bmatrix}$$

3×3

vector of strain components:

$$\begin{Bmatrix} \varepsilon_x \\ \varepsilon_y \\ \varepsilon_z \\ \gamma_{xy} \\ \gamma_{yz} \\ \gamma_{zx} \end{Bmatrix}_{6 \times 1} = \begin{bmatrix} \frac{\partial}{\partial x} & 0 & 0 \\ 0 & \frac{\partial}{\partial y} & 0 \\ 0 & 0 & \frac{\partial}{\partial z} \\ \frac{\partial}{\partial y} & \frac{\partial}{\partial x} & 0 \\ 0 & \frac{\partial}{\partial z} & \frac{\partial}{\partial y} \\ \frac{\partial}{\partial z} & 0 & \frac{\partial}{\partial x} \end{bmatrix} \begin{Bmatrix} u \\ v \\ w \end{Bmatrix} = [R] \{u\} \quad ; \quad [\varepsilon] = [u][R]^T$$

$6 \times 3 \quad 3 \times 1$

↑
gradient matrix

$1 \times 6 \quad 1 \times 3 \quad 3 \times 6$

Strain – displacement matrix of a finite element

nodal approximation in a finite element:

$$\{u\} = [N(\xi, \eta, \zeta)]\{q\}_e$$

3×1 $3 \times n_e$ $n_e \times 1$

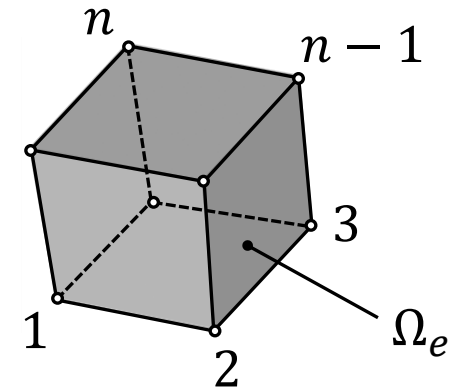

vector of strain components in a finite element:

$$\{\varepsilon\} = [R]\{u\} = [R][N]\{q\}_e = [B]\{q\}_e \quad ; \quad [\varepsilon] = [q]_e [B]^T$$

6×1 6×3 3×1 6×3 $3 \times n_e$ $n_e \times 1$ $6 \times n_e$ $n_e \times 1$ 1×6 $1 \times n_e$ $n_e \times 6$

$$[B] = [R][N] \text{ — strain–displacement matrix}$$

$6 \times n_e$ 6×3 $3 \times n_e$

Stress components

normal stresses:

$$\sigma_x ; \sigma_y ; \sigma_z$$

positive value - tension, negative value - compression

shear stress components:

$$\tau_{xy} ; \tau_{yz} ; \tau_{zx} ; \tau_{ij} = \tau_{ji}$$

equivalent stresses:

Von Mises stress:

$$\sigma_{EQV} = \sqrt{\frac{1}{2} \left((\sigma_x - \sigma_y)^2 + (\sigma_y - \sigma_z)^2 + (\sigma_z - \sigma_x)^2 \right) + 3(\tau_{xy}^2 + \tau_{yz}^2 + \tau_{zx}^2)}$$

$$\text{Tresca stress: } \sigma_{INT} = \sigma_1 - \sigma_3 = 2\tau_{max}$$

the first principal stress *the third principal stress*

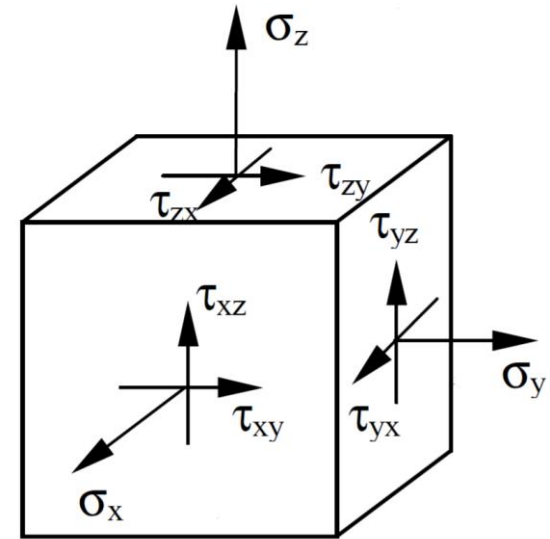

maximum shear stress

Stress tensor. Vector of stress components

stress tensor:

$$\boldsymbol{\sigma} = \begin{matrix} & & & \\ & & & \\ & & & \\ \text{\scriptsize } 3 \times 3 & \begin{bmatrix} \sigma_x & \tau_{xy} & \tau_{xz} \\ \tau_{yx} & \sigma_y & \tau_{yz} \\ \tau_{zx} & \tau_{zy} & \sigma_z \end{bmatrix} & \equiv & \begin{bmatrix} \sigma_1 & 0 & 0 \\ 0 & \sigma_2 & 0 \\ 0 & 0 & \sigma_3 \end{bmatrix} \end{matrix}$$

in the coordinate system x, y, z

in the principal coordinate system

vector of stress components:

$$\{\boldsymbol{\sigma}\}_{6 \times 1} = \left\{ \begin{array}{c} \sigma_x \\ \sigma_y \\ \sigma_z \\ \tau_{xy} \\ \tau_{yz} \\ \tau_{zx} \end{array} \right\}$$

Constitutive matrix

linear isotropic material (Hooke's law):

$$\begin{matrix} \{\sigma\} = [D] \{\varepsilon\} \\ 6 \times 1 \quad 6 \times 6 \quad 6 \times 1 \end{matrix}$$



constitutive matrix

$$[D]_{6 \times 6} = \frac{E}{(1+\nu)(1-2\nu)} \begin{bmatrix} 1-\nu & \nu & \nu & 0 & 0 & 0 \\ \nu & 1-\nu & \nu & 0 & 0 & 0 \\ \nu & \nu & 1-\nu & 0 & 0 & 0 \\ 0 & 0 & 0 & 0.5-\nu & 0 & 0 \\ 0 & 0 & 0 & 0 & 0.5-\nu & 0 \\ 0 & 0 & 0 & 0 & 0 & 0.5-\nu \end{bmatrix}$$

E – Young's modulus, *ν* – Poisson's ratio

Example: uniaxial tensile test

$$\sigma_x = \frac{F}{A_0} \quad ; \quad \varepsilon_x = \frac{L-L_0}{L_0} \quad ; \quad \varepsilon_y = \varepsilon_z$$

elastic strain energy: $U = \frac{1}{2} \sigma_x \varepsilon_x A_0 L_0$

$$\begin{matrix} \{\sigma\} \\ 6 \times 1 \end{matrix} = \begin{matrix} [D] \\ 6 \times 6 \end{matrix} \begin{matrix} \{\varepsilon\} \\ 6 \times 1 \end{matrix}$$

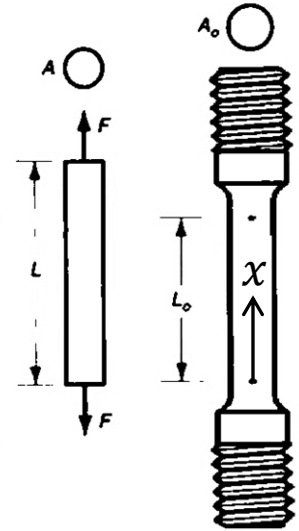
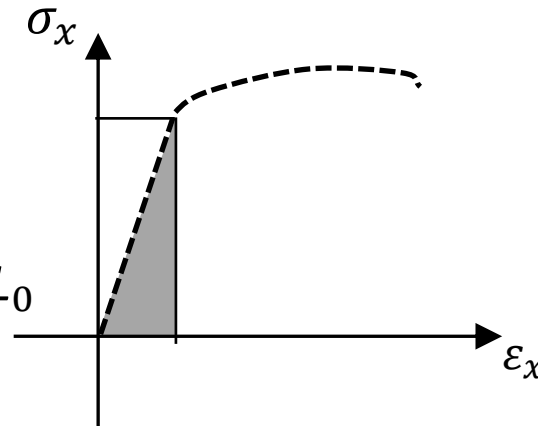

$$\begin{Bmatrix} \sigma_x \\ 0 \\ 0 \\ 0 \\ 0 \\ 0 \end{Bmatrix} = \frac{E}{(1+\nu)(1-2\nu)} \begin{bmatrix} 1-\nu & \nu & \nu & 0 & 0 & 0 \\ \nu & 1-\nu & \nu & 0 & 0 & 0 \\ \nu & \nu & 1-\nu & 0 & 0 & 0 \\ 0 & 0 & 0 & 0.5-\nu & 0 & 0 \\ 0 & 0 & 0 & 0 & 0.5-\nu & 0 \\ 0 & 0 & 0 & 0 & 0 & 0.5-\nu \end{bmatrix} \begin{Bmatrix} \varepsilon_x \\ \varepsilon_y \\ \varepsilon_z \\ 0 \\ 0 \\ 0 \end{Bmatrix}$$

2nd equation:

$$0 = \frac{E}{(1+\nu)(1-2\nu)} (\nu\varepsilon_x + (1-\nu)\varepsilon_y + \nu\varepsilon_z) \rightarrow \boxed{\varepsilon_y = -\nu\varepsilon_x} ; (\varepsilon_z = -\nu\varepsilon_x)$$

1st Equation:

$$\sigma_x = \frac{E}{(1+\nu)(1-2\nu)} ((1-\nu)\varepsilon_x + \nu\varepsilon_y + \nu\varepsilon_z) = \frac{E}{(1-\nu-2\nu^2)} ((1-\nu)\varepsilon_x - \nu^2\varepsilon_x - \nu^2\varepsilon_x) \rightarrow \boxed{\sigma_x = E\varepsilon_x}$$

(Hooke's law for the uniaxial stress state)

Example: pure shear

$$\tau_{xy} ; \gamma_{xy}$$

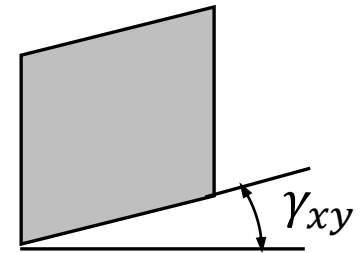
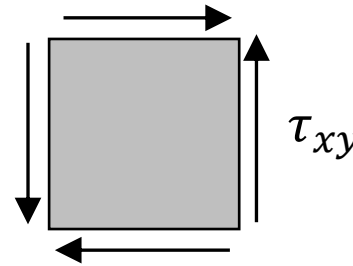

$$\{\sigma\} = [D] \{\varepsilon\}$$

$6 \times 1 \quad 6 \times 6 \quad 6 \times 1$

$$\begin{Bmatrix} 0 \\ 0 \\ 0 \\ \tau_{xy} \\ 0 \\ 0 \end{Bmatrix} = \frac{E}{(1+\nu)(1-2\nu)} \begin{bmatrix} 1-\nu & \nu & \nu & 0 & 0 & 0 \\ \nu & 1-\nu & \nu & 0 & 0 & 0 \\ \nu & \nu & 1-\nu & 0 & 0 & 0 \\ 0 & 0 & 0 & 0.5-\nu & 0 & 0 \\ 0 & 0 & 0 & 0 & 0.5-\nu & 0 \\ 0 & 0 & 0 & 0 & 0 & 0.5-\nu \end{bmatrix} \begin{Bmatrix} 0 \\ 0 \\ 0 \\ \gamma_{xy} \\ 0 \\ 0 \end{Bmatrix}$$

4th equation:

$$\tau_{xy} = \frac{E}{(1+\nu)(1-2\nu)} (0.5 - \nu) \gamma_{xy} = \frac{E}{2(1+\nu)(0.5-\nu)} (0.5 - \nu) \gamma_{xy} = \frac{E}{2(1+\nu)} \gamma_{xy} \rightarrow$$

$$\tau_{xy} = G \gamma_{xy}$$

$$G = \frac{E}{2(1+\nu)} - \text{Kirchoff's modulus (shear modulus)}$$

(Hooke's law for the pure shear stress state)

Elastic strain energy. Potential energy of loading

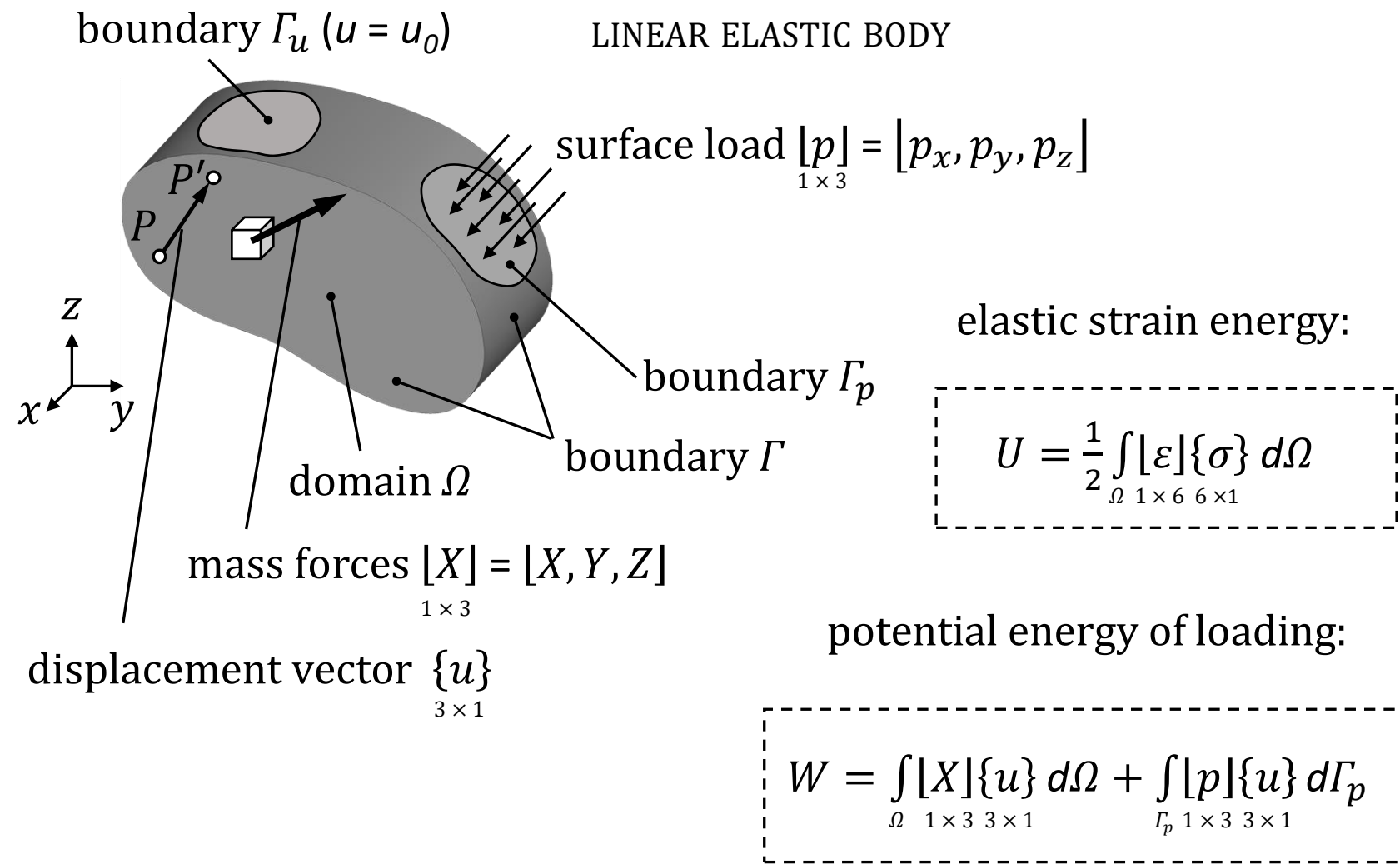

Minimum total potential energy principle

total potential energy: $V = U - W$

The displacement field $\{u\}$ that represents solution of the problem fulfils displacement boundary conditons on Γ_u and minimizes the total potential energy V .

$V \rightarrow \min$

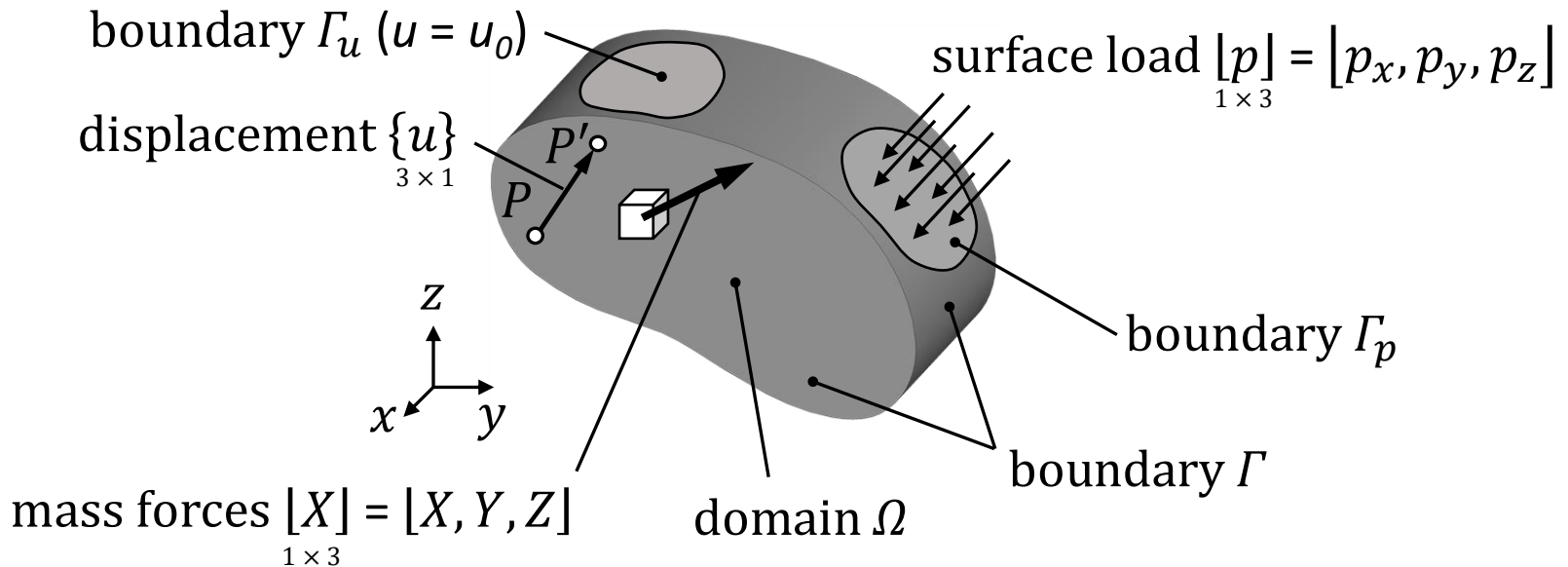

Elastic strain energy in a finite element. Local stiffness matrix

$\{q\}_e$ - local vector of nodal parameters
 $n_e \times 1$

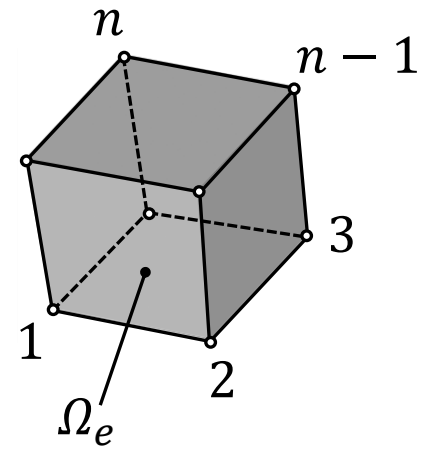

elastic strain energy in a finite element:

$$U_e = \frac{1}{2} \int_{\Omega_e} [\varepsilon] \{\sigma\} d\Omega_e = \frac{1}{2} [q]_e \int_{\Omega_e} [B]^T [D] [B] d\Omega_e \{q\}_e = \frac{1}{2} [q]_e [k]_e \{q\}_e$$

1×6 6×1 $1 \times n_e$ Ω_e $n_e \times 6$ 6×6 $6 \times n_e$ $n_e \times 1$ $1 \times n_e$ $n_e \times n_e$ $n_e \times 1$

$$\{\sigma\} = [D] \{\varepsilon\}$$

6×1 6×6 6×1

$$[\varepsilon] = [q]_e [B]^T \quad \{\varepsilon\} = [B] \{q\}_e$$

1×6 $1 \times n_e$ $n_e \times 6$ 6×1 $6 \times n_e$ $n_e \times 1$

local stiffness matrix:

$$[k]_e = \int_{\Omega_e} [B]^T [D] [B] d\Omega_e$$

$n_e \times n_e$ Ω_e $n_e \times 6$ 6×6 $6 \times n_e$

Elastic strain energy in a finite element

local notation:

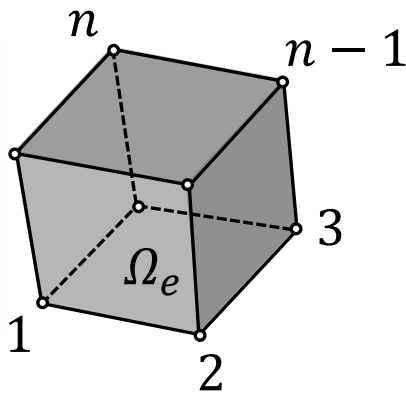

n – no. of nodes per FE

n_p – no. of nodal parameters per node

no. of degrees of freedom in FE:

$$n_e = n \cdot n_p$$

$\{q\}_e$ - local vector of nodal parameters
 $n_e \times 1$

$$U_e = \frac{1}{2} [q]_e [k]_e \{q\}_e$$

$1 \times n_e \quad n_e \times n_e \quad n_e \times 1$

↑
local stiffness matrix

global notation:

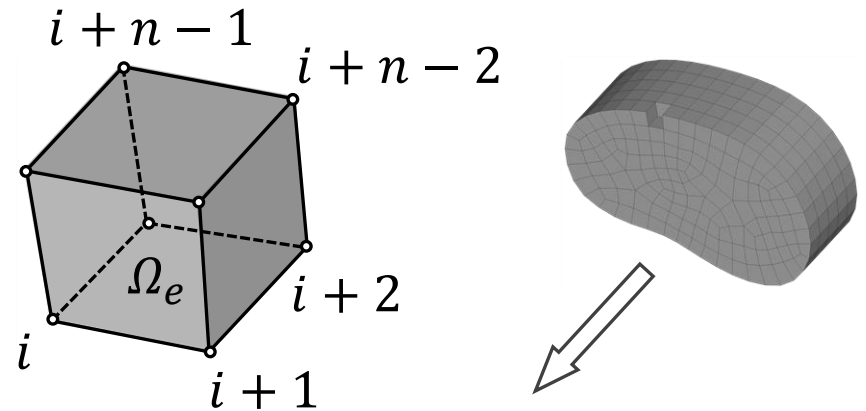

NON – no. of nodes

n_p – no. of nodal parameters per node

no. of degrees of freedom:

$$NDOF = NON \cdot n_p$$

$\{q\}$ - global vector of nodal parameters
 $NDOF \times 1$

$$U_e = \frac{1}{2} \cdot [q] \cdot [k]_e^* \cdot \{q\}$$

$1 \times NDOF \quad NDOF \times NDOF \quad NDOF \times 1$

↑
extended local stiffness matrix

Extended local stiffness matrix of a finite element

$$\{q\}_{NDOF \times 1} = \begin{Bmatrix} q_1 \\ q_2 \\ \vdots \\ q_j \\ \vdots \\ q_{NDOF} \end{Bmatrix}$$

$$[k]_e^* =$$

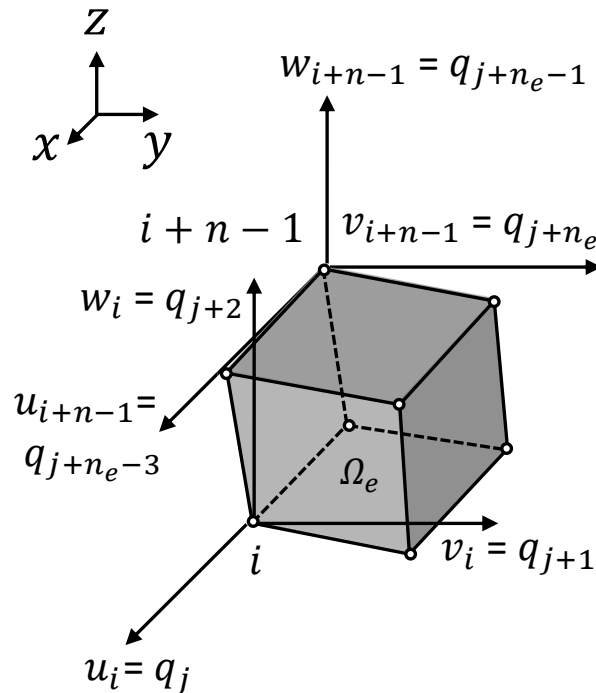

	1	2	...	$j-1$	j	$j+1$...	$j+n_e-1$	$j+n_e$...	NDOF
1	0	0	...	0	0	0	...	0	0	...	0
2	0	0	...	0	0	0	...	0	0	...	0
...	0	0	0	...	0	0	...	0
$j-1$	0	0	0	0	0	0	...	0	0	...	0
j	0	0	0	0	k_{11}	k_{12}	...	k_{1n_e}	0	...	0
$j+1$	0	0	0	0	k_{21}	k_{22}	...	k_{2n_e}	0	...	0
...	0	...	0
$j+n_e-1$	0	0	0	0	k_{n_e1}	k_{n_e2}	...	$k_{n_en_e}$	0	...	0
$j+n_e$	0	0	0	0	0	0	0	0	0	...	0
...	0
NDOF	0	0	0	0	0	0	0	0	0	0	0

(assumed ascending order of components)

Elastic strain energy in a FE model. Global stiffness matrix

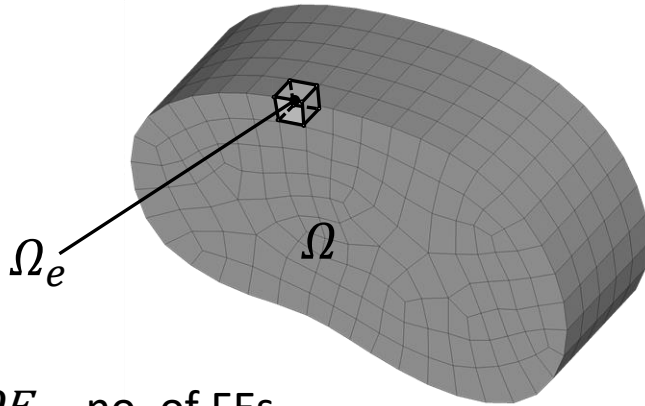

$$\Omega = \sum_{e=1}^{NOE} \Omega_e \rightarrow$$

$$U = \sum_{e=1}^{NOE} U_e$$

NOE – no. of FEs

NDOF – no. of degrees of freedom

$\{q\}$ - global vector of nodal parameters
NDOF × 1

elastic strain energy in a finite element model:

$$\begin{aligned}
 U &= \sum_{e=1}^{NOE} U_e = \sum_{e=1}^{NOE} \frac{1}{2} \cdot [q] \cdot [k]_e^* \cdot \{q\} = \frac{1}{2} [q] \cdot \sum_{e=1}^{NOE} [k]_e^* \cdot \{q\} = \\
 &= \frac{1}{2} \cdot [q] \cdot [K] \cdot \{q\}
 \end{aligned}$$

$1 \times NDOF$ $NDOF \times NDOF$ $NDOF \times 1$ $1 \times NDOF$ $NDOF \times NDOF$ $NDOF \times 1$

↑
global stiffness matrix:

$$[K] = \sum_{e=1}^{NOE} [k]_e^*$$

NDOF × *NDOF*

Example: global stiffness matrix of a 2D model with two 3-node triangles

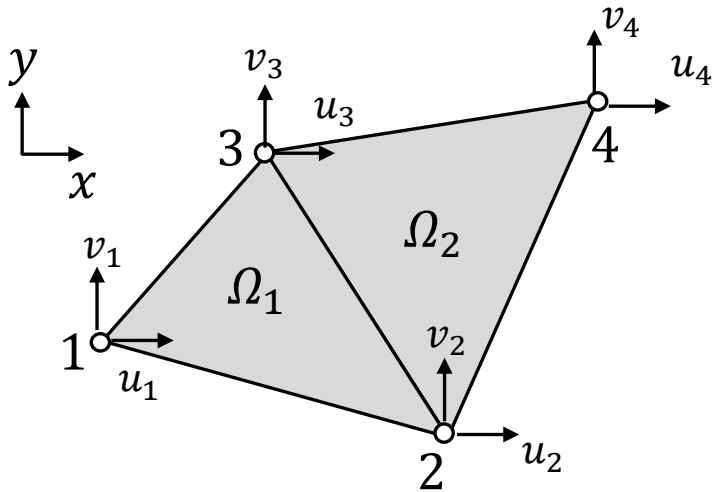

global notation:

$$\begin{aligned}
 NOE &= 2 \\
 NON &= 4 \\
 n &= 3 \\
 n_p &= 2 \quad ; \quad (u, v) \\
 n_e &= n \cdot n_p = 6 \\
 NDOF &= NON \cdot n_p = 8
 \end{aligned}$$

$$\{q\}_{8 \times 1} = \begin{Bmatrix} q_1 \\ q_2 \\ q_3 \\ q_4 \\ q_5 \\ q_6 \\ q_7 \\ q_8 \end{Bmatrix} = \begin{Bmatrix} u_1 \\ v_1 \\ u_2 \\ v_2 \\ u_3 \\ v_3 \\ u_4 \\ v_4 \end{Bmatrix}$$

local notation:

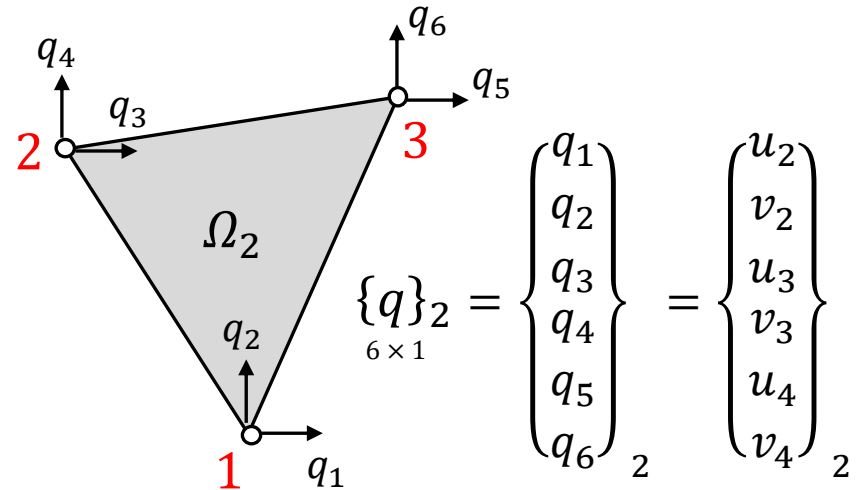
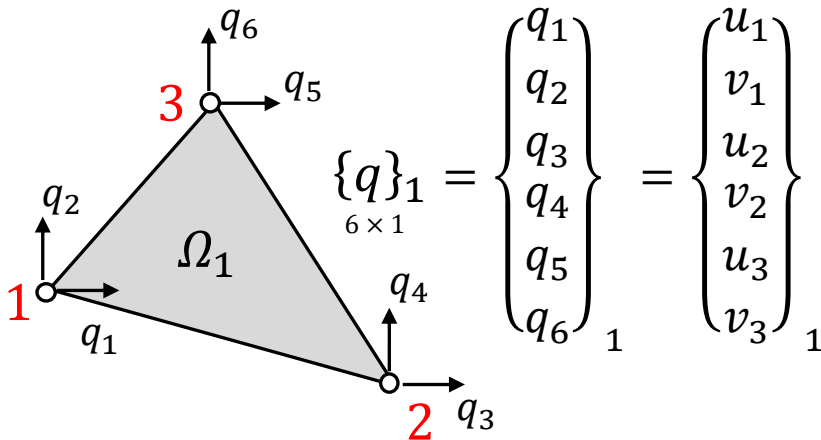

Example: global stiffness matrix of a 2D model with two 3-node triangles

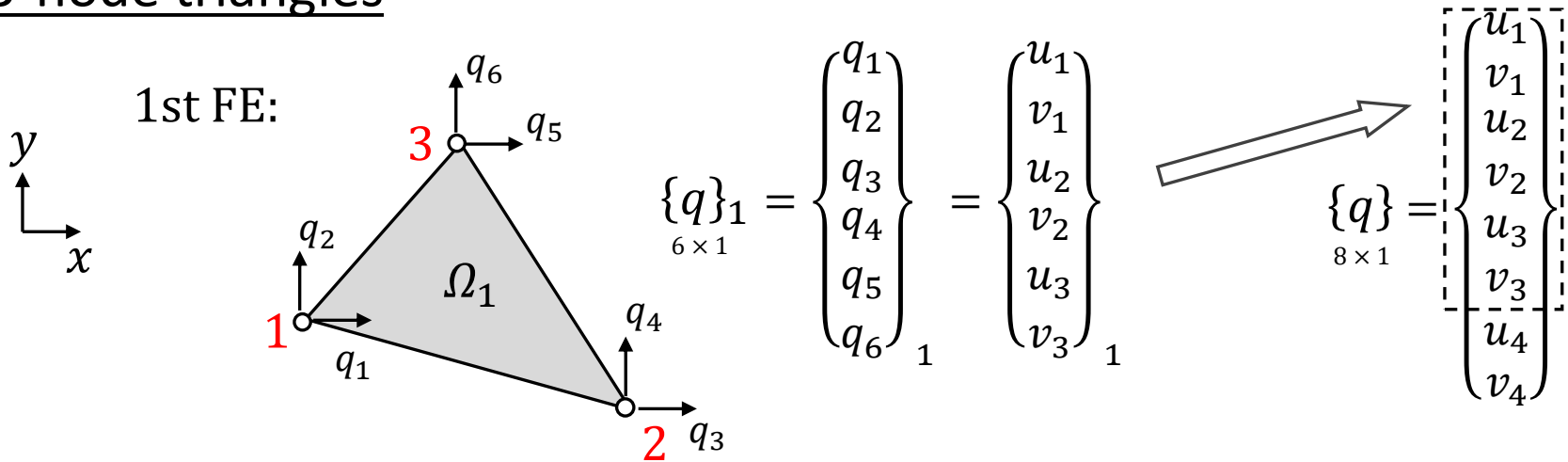

$$[k]_1 = \begin{matrix} & \begin{matrix} 1 & 2 & 3 & 4 & 5 & 6 \end{matrix} \\ \begin{matrix} 1 \\ 2 \\ 3 \\ 4 \\ 5 \\ 6 \end{matrix} & \begin{bmatrix} a_1 & b_1 & c_1 & d_1 & e_1 & f_1 \\ b_1 & g_1 & h_1 & i_1 & j_1 & k_1 \\ c_1 & h_1 & l_1 & m_1 & n_1 & o_1 \\ d_1 & i_1 & m_1 & p_1 & r_1 & s_1 \\ e_1 & j_1 & n_1 & r_1 & t_1 & \bar{u}_1 \\ f_1 & k_1 & o_1 & s_1 & \bar{u}_1 & \bar{w}_1 \end{bmatrix} \end{matrix}$$

$$[k]_1^* = \begin{matrix} & \begin{matrix} 1 & 2 & 3 & 4 & 5 & 6 & 7 & 8 \end{matrix} \\ \begin{matrix} 1 \\ 2 \\ 3 \\ 4 \\ 5 \\ 6 \\ 7 \\ 8 \end{matrix} & \begin{bmatrix} a_1 & b_1 & c_1 & d_1 & e_1 & f_1 & 0 & 0 \\ b_1 & g_1 & h_1 & i_1 & j_1 & k_1 & 0 & 0 \\ c_1 & h_1 & l_1 & m_1 & n_1 & o_1 & 0 & 0 \\ d_1 & i_1 & m_1 & p_1 & r_1 & s_1 & 0 & 0 \\ e_1 & j_1 & n_1 & r_1 & t_1 & \bar{u}_1 & 0 & 0 \\ f_1 & k_1 & o_1 & s_1 & \bar{u}_1 & \bar{w}_1 & 0 & 0 \\ 0 & 0 & 0 & 0 & 0 & 0 & 0 & 0 \\ 0 & 0 & 0 & 0 & 0 & 0 & 0 & 0 \end{bmatrix} \end{matrix}$$

Example: global stiffness matrix of a 2D model with two 3-node triangles

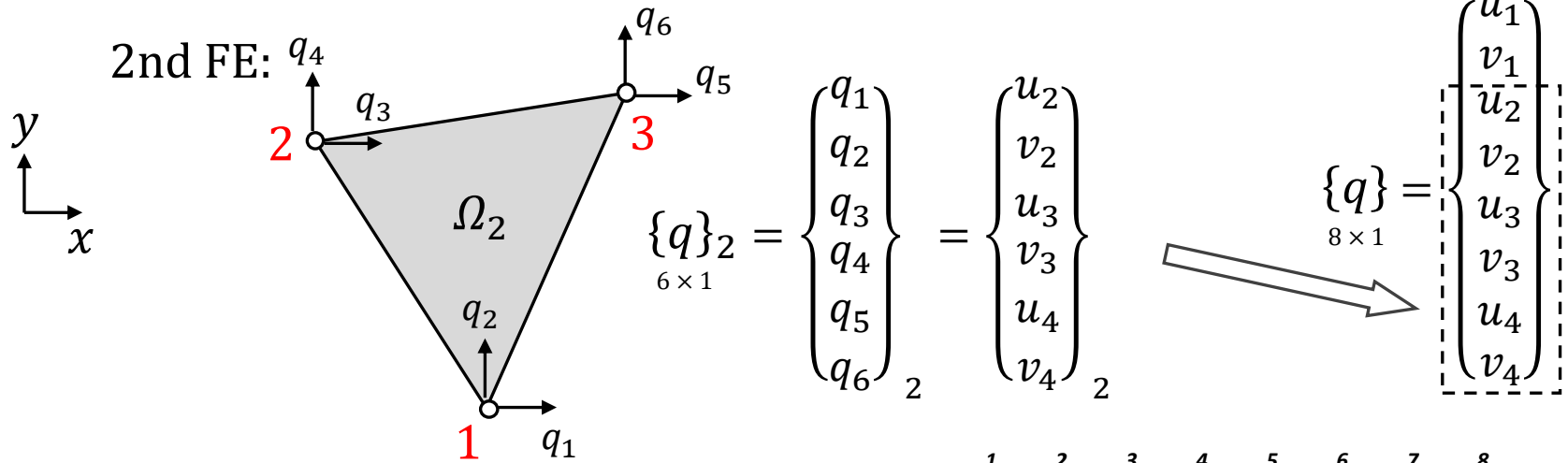

$$[k]_2 = \begin{matrix} & \begin{matrix} 1 & 2 & 3 & 4 & 5 & 6 \end{matrix} \\ \begin{matrix} 1 \\ 2 \\ 3 \\ 4 \\ 5 \\ 6 \end{matrix} & \begin{bmatrix} a_2 & b_2 & c_2 & d_2 & e_2 & f_2 \\ b_2 & g_2 & h_2 & i_2 & j_2 & k_2 \\ c_2 & h_2 & l_2 & m_2 & n_2 & o_2 \\ d_2 & i_2 & m_2 & p_2 & r_2 & s_2 \\ e_2 & j_2 & n_2 & r_2 & t_2 & \bar{u}_2 \\ f_2 & k_2 & o_2 & s_2 & \bar{u}_2 & \bar{w}_2 \end{bmatrix} \end{matrix}$$

$$[k]_2^* = \begin{matrix} & \begin{matrix} 1 & 2 & 3 & 4 & 5 & 6 & 7 & 8 \end{matrix} \\ \begin{matrix} 1 \\ 2 \\ 3 \\ 4 \\ 5 \\ 6 \\ 7 \\ 8 \end{matrix} & \begin{bmatrix} 0 & 0 & 0 & 0 & 0 & 0 & 0 & 0 \\ 0 & 0 & 0 & 0 & 0 & 0 & 0 & 0 \\ 0 & 0 & a_2 & b_2 & c_2 & d_2 & e_2 & f_2 \\ 0 & 0 & b_2 & g_2 & h_2 & i_2 & j_2 & k_2 \\ 0 & 0 & c_2 & h_2 & l_2 & m_2 & n_2 & o_2 \\ 0 & 0 & d_2 & i_2 & m_2 & p_2 & r_2 & s_2 \\ 0 & 0 & e_2 & j_2 & n_2 & r_2 & t_2 & \bar{u}_2 \\ 0 & 0 & f_2 & k_2 & o_2 & s_2 & \bar{u}_2 & \bar{w}_2 \end{bmatrix} \end{matrix}$$

Example: global stiffness matrix of a 2D model with two 3-node triangles

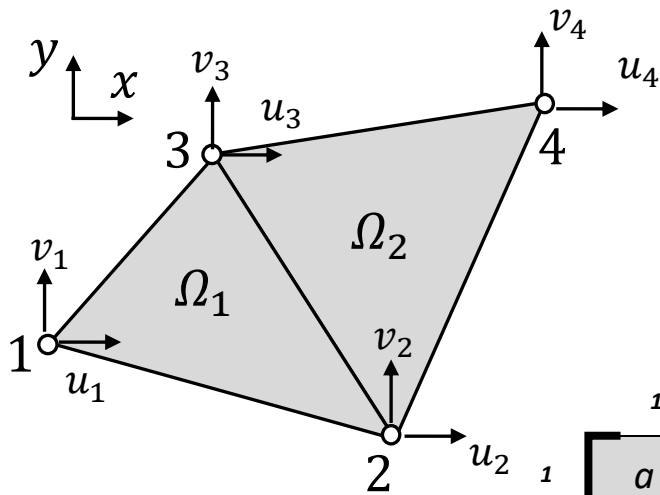

$$\{q\}_{8 \times 1} = \begin{Bmatrix} u_1 \\ v_1 \\ u_2 \\ v_2 \\ u_3 \\ v_3 \\ u_4 \\ v_4 \end{Bmatrix}$$

$$[K]_{8 \times 8} = [k]_1^* + [k]_2^* =$$

	1	2	3	4	5	6	7	8
1	a_1	b_1	c_1	d_1	e_1	f_1	0	0
2	b_1	g_1	h_1	i_1	j_1	k_1	0	0
3	c_1	h_1	l_1+a_2	m_1+b_2	n_1+c_2	o_1+d_2	e_2	f_2
4	d_1	i_1	m_1+b_2	p_1+g_2	r_1+h_2	s_1+i_2	j_2	k_2
5	e_1	j_1	n_1+c_2	r_1+h_2	t_1+l_2	\bar{u}_1+m_2	n_2	o_2
6	f_1	k_1	o_1+d_2	t_1+l_2	\bar{u}_1+m_2	\bar{w}_1+p_2	r_2	s_2
7	0	0	e_2	j_2	n_2	r_2	t_2	\bar{u}_2
8	0	0	f_2	k_2	o_2	s_2	\bar{u}_2	\bar{w}_2

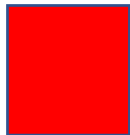

Equivalent load vector

$$[F]_e = [F^X]_e + [F^p]_e$$

$1 \times n_e \quad 1 \times n_e \quad 1 \times n_e$

equivalent load vector due to mass forces:

$$[F^X]_e = \int_{\Omega_e} [X][N] d\Omega_e =$$

$1 \times n_e \quad \Omega_e \quad 1 \times 3 \quad 3 \times n_e$

$$= \int_{\Omega_e} [X, Y, Z] \begin{bmatrix} N_1 & 0 & 0 & N_2 & 0 & 0 & N_n & 0 & 0 \\ 0 & N_1 & 0 & 0 & N_2 & 0 & \dots & 0 & N_n & 0 \\ 0 & 0 & N_1 & 0 & 0 & N_2 & 0 & 0 & 0 & N_n \end{bmatrix} d\Omega_e$$

equivalent load vector due to surface load:

$$[F^p]_e = \int_{\Gamma_{pe}} [p][N] d\Gamma_{pe} =$$

$1 \times n_e \quad \Gamma_{pe} \quad 1 \times 3 \quad 3 \times n_e$

$$= \int_{\Gamma_{pe}} [p_x, p_y, p_z] \begin{bmatrix} N_1 & 0 & 0 & N_2 & 0 & 0 & N_n & 0 & 0 \\ 0 & N_1 & 0 & 0 & N_2 & 0 & \dots & 0 & N_n & 0 \\ 0 & 0 & N_1 & 0 & 0 & N_2 & 0 & 0 & 0 & N_n \end{bmatrix} d\Gamma_{pe}$$

Potential energy of loading in a finite element

local notation:

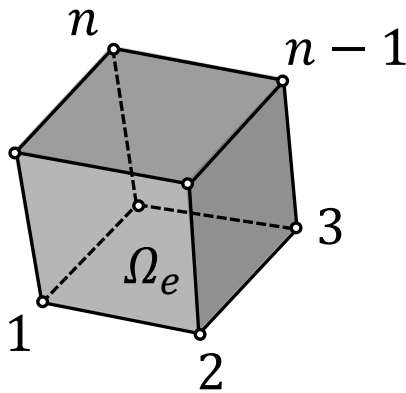

n – no. of nodes per FE

n_p – no. of nodal parameters per node

no. of degrees of freedom in FE:

$$n_e = n \cdot n_p$$

$\{q\}_e$ - local vector of nodal parameters
 $n_e \times 1$

$$W_e = [q]_e \{F\}_e$$

$1 \times n_e \quad n_e \times 1$

↑
equivalent load vector

global notation:

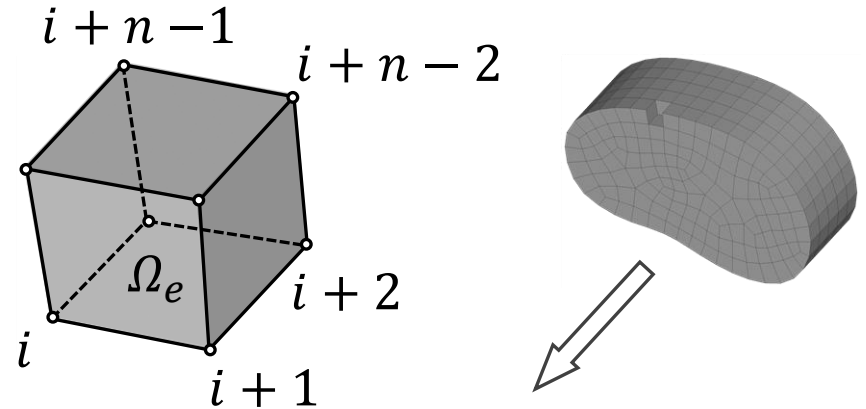

NON – no. of nodes

n_p – no. of nodal parameters per node

no. of degrees of freedom:

$$NDOF = NON \cdot n_p$$

$\{q\}$ - global vector of nodal parameters
 $NDOF \times 1$

$$W_e = [q] \cdot \{F\}_e^*$$

$1 \times NDOF \quad NDOF \times 1$

↑
extended equivalent load vector

Extended equivalent load vector in a finite element

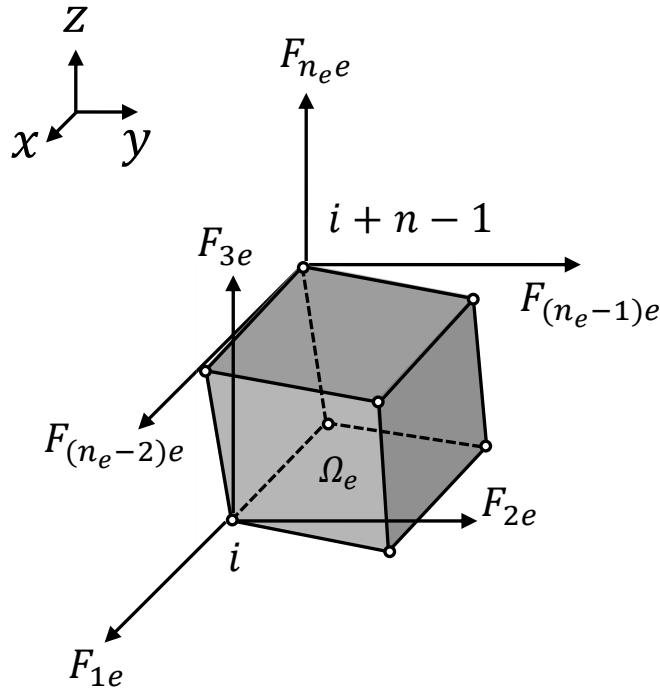

equivalent load vector:

$$\{F\}_e = \begin{Bmatrix} F_{1e} \\ F_{2e} \\ F_{3e} \\ \dots \\ F_{(n_e-2)e} \\ F_{(n_e-1)e} \\ F_{n_e e} \end{Bmatrix}$$

$n_e \times 1$

extended equivalent load vector:

$$\{F\}_e^* = \begin{Bmatrix} 0 \\ 0 \\ \dots \\ 0 \\ F_{1e} \\ F_{2e} \\ \dots \\ F_{n_e e} \\ 0 \\ \dots \\ 0 \end{Bmatrix}$$

$NDOF \times 1$

(assumed ascending order of components)

Forces applied directly on nodes. Potential energy of nodal loads

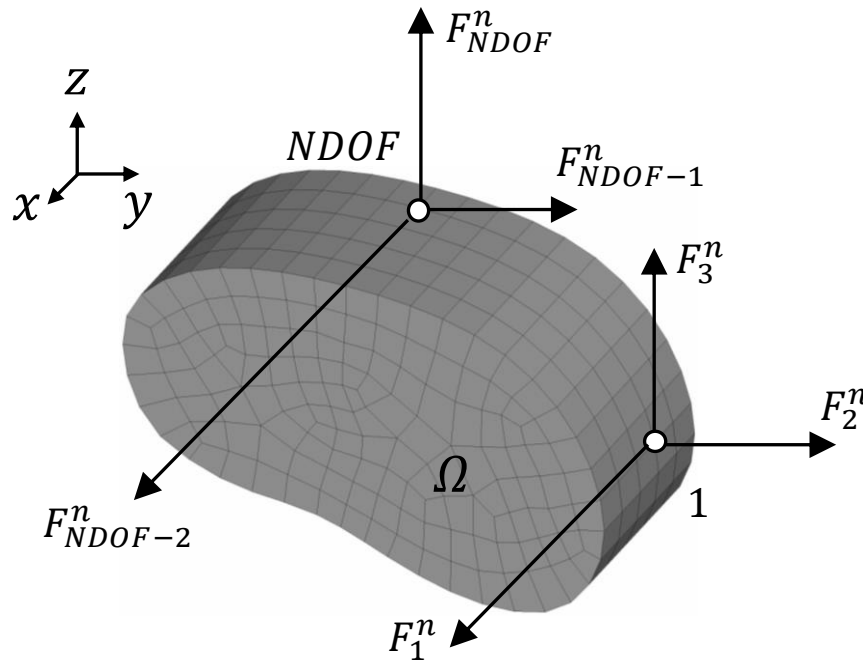

nodal load vector:

$$\{F\}_{NDOF \times 1}^n = \left\{ \begin{array}{c} F_1^n \\ F_2^n \\ F_3^n \\ \dots \\ F_{NDOF-2}^n \\ F_{NDOF-1}^n \\ F_{NDOF}^n \end{array} \right\}$$

potential energy of nodal loads:

$$W^n = [q]_{1 \times NDOF} \cdot \{F\}_{NDOF \times 1}^n$$

Potential energy of loading in a FE model. Global load vector

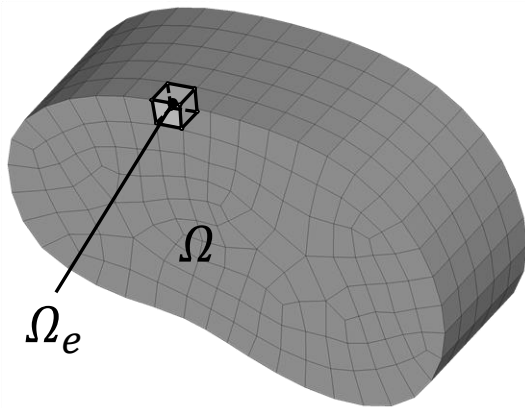

potential energy of element loads:

$$\Omega = \sum_{e=1}^{NOE} \Omega_e \rightarrow \boxed{W^e = \sum_{e=1}^{NOE} W_e}$$

NOE – no. of FEs

NDOF – no. of degrees of freedom

potential energy of loading in a finite element model:

$$\boxed{W = W^e + W^n}$$

$$W = \sum_{e=1}^{NOE} W_e + W^n = \sum_{e=1}^{NOE} [q] \cdot \{F\}_e^* + [q] \cdot \{F\}^n = [q] \cdot \left(\sum_{e=1}^{NOE} \{F\}_e^* + \{F\}^n \right)$$

$1 \times NDOF$ $NDOF \times 1$ $1 \times NDOF$ $NDOF \times 1$ $1 \times NDOF$ $NDOF \times 1$ $NDOF \times 1$ $NDOF \times 1$

$$= [q] \cdot (\{F\}^e + \{F\}^n) \rightarrow W = [q] \cdot \{F\}$$

$1 \times NDOF$ $NDOF \times 1$ $NDOF \times 1$ $1 \times NDOF$ $NDOF \times 1$

↑
global load vector
of element loads

↑
global load vector:

$$\boxed{\{F\} = \{F\}^e + \{F\}^n}$$

$NDOF \times 1$ $NDOF \times 1$ $NDOF \times 1$

Total potential energy in a FE model. Set of linear equations

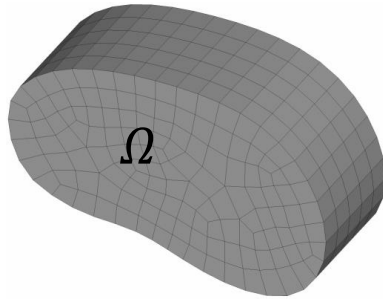

Total potential energy of the entire model:

$$V = U - W = \frac{1}{2} \cdot \underset{1 \times NDOF}{[q]} \cdot \underset{NDOF \times NDOF}{[K]} \cdot \underset{NDOF \times 1}{\{q\}} - \underset{1 \times NDOF}{[q]} \cdot \underset{NDOF \times 1}{\{F\}}$$

$$\underset{NDOF \times 1}{\{q\}} = ?$$

$V \rightarrow \min$

NOE – no. of FEs

$NDOF$ – no. of degrees of freedom

$$\frac{\partial V}{\partial q_j} = 0 \rightarrow \boxed{\underset{NDOF \times NDOF}{[K]} \cdot \underset{NDOF \times 1}{\{q\}} = \underset{NDOF \times 1}{\{F\}}}$$



set of linear algebraic equations

$$\det ([K]) = 0$$

$NDOF \times NDOF$

Set of FE equations with boundary conditions

The displacement field $\{u\}$ that represents solution of the problem fulfils displacement boundary conditons on Γ_u and minimizes the total potential energy V .

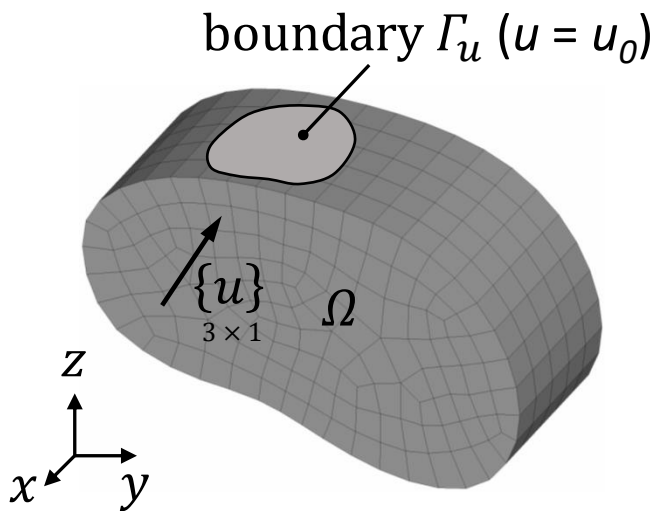

$NDOF$ – no. of degrees of freedom

NOF – no. of known degrees of freedom on Γ_u

N – number of unknown degrees of freedom:

$$N = NDOF - NOF$$

$$\begin{array}{ccccccc}
 [K] & \rightarrow & [K] & ; & \{q\} & \rightarrow & \{q\} & ; & \{F\} & \rightarrow & \{F\} \\
 NDOF \times NDOF & & N \times N & & NDOF \times 1 & & N \times 1 & & NDOF \times 1 & & N \times 1
 \end{array}$$

$$\boxed{
 \begin{array}{ccc}
 [K] \cdot \{q\} & = & \{F\} \\
 N \times N & & N \times 1 & & N \times 1
 \end{array}
 }$$

$$\det ([K]) \neq 0 \\
 N \times N$$

↑
linear set of algebraic equations with boundary conditions

Example. Boundary conditions for 2D problem. FE model with two 3-node triangles

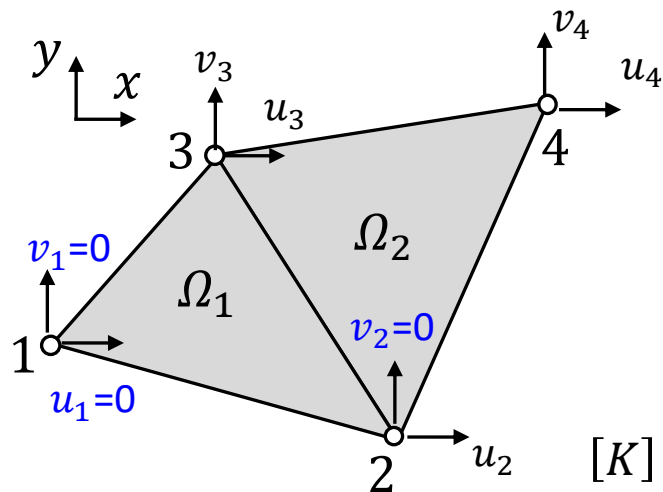

$NDOF = 8$

$NOF = 3$

$$[K] \cdot \{q\} = \{F\}$$

$8 \times 8 \quad \quad 8 \times 1 \quad \quad 8 \times 1$

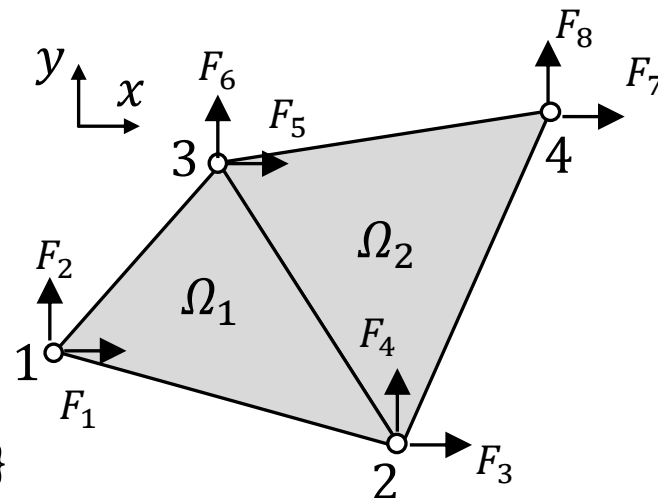

	1	2	3	4	5	6	7	8
1	a_1	b_1	c_1	d_1	e_1	f_1	0	0
2	b_1	g_1	h_1	i_1	j_1	k_1	0	0
3	c_1	h_1	l_1+a_2	m_1+b_2	n_1+c_2	o_1+d_2	e_2	f_2
4	d_1	i_1	m_1+b_2	p_1+g_2	r_1+h_2	s_1+i_2	j_2	k_2
5	e_1	j_1	n_1+c_2	r_1+h_2	t_1+l_2	\bar{u}_1+m_2	n_2	o_2
6	f_1	k_1	o_1+d_2	t_1+l_2	\bar{u}_1+m_2	\bar{w}_1+p_2	r_2	s_2
7	0	0	e_2	j_2	n_2	r_2	t_2	\bar{u}_2
8	0	0	f_2	k_2	o_2	s_2	\bar{u}_2	\bar{w}_2

$$\begin{Bmatrix} u_1 = 0 \\ v_1 = 0 \\ u_2 \\ v_2 = 0 \\ u_3 \\ v_3 \\ u_4 \\ v_4 \end{Bmatrix} = \begin{Bmatrix} F_1 \\ F_2 \\ F_3 \\ F_4 \\ F_5 \\ F_6 \\ F_7 \\ F_8 \end{Bmatrix}$$

Example. Boundary conditions for 2D problem. FE model with two 3-node triangles

$$NDOF = 8 \quad ; \quad NOF = 3 \quad ; \quad N = NDOF - NOF = 5$$

$$\underbrace{\{q\}}_{8 \times 1} = \underbrace{[C]}_{8 \times 5} \cdot \underbrace{\{q\}}_{5 \times 1} \quad ; \quad \underbrace{[q]}_{1 \times 8} = \underbrace{[q]}_{1 \times 5} \cdot \underbrace{[C]^T}_{5 \times 8}$$

$$\begin{Bmatrix} 0 \\ 0 \\ u_2 \\ 0 \\ u_3 \\ v_3 \\ u_4 \\ v_4 \end{Bmatrix} = \begin{bmatrix} 0 & 0 & 0 & 0 & 0 \\ 0 & 0 & 0 & 0 & 0 \\ 1 & 0 & 0 & 0 & 0 \\ 0 & 0 & 0 & 0 & 0 \\ 0 & 1 & 0 & 0 & 0 \\ 0 & 0 & 1 & 0 & 0 \\ 0 & 0 & 0 & 1 & 0 \\ 0 & 0 & 0 & 0 & 1 \end{bmatrix} \cdot \begin{Bmatrix} u_2 \\ u_3 \\ v_3 \\ u_4 \\ v_4 \end{Bmatrix}$$

$$\underbrace{[C]}_{8 \times 5} = \begin{bmatrix} 0 & 0 & 0 & 0 & 0 \\ 0 & 0 & 0 & 0 & 0 \\ 1 & 0 & 0 & 0 & 0 \\ 0 & 0 & 0 & 0 & 0 \\ 0 & 1 & 0 & 0 & 0 \\ 0 & 0 & 1 & 0 & 0 \\ 0 & 0 & 0 & 1 & 0 \\ 0 & 0 & 0 & 0 & 1 \end{bmatrix} \quad ; \quad \underbrace{[C]^T}_{5 \times 8} = \begin{bmatrix} 0 & 0 & 1 & 0 & 0 & 0 & 0 & 0 \\ 0 & 0 & 0 & 0 & 1 & 0 & 0 & 0 \\ 0 & 0 & 0 & 0 & 0 & 1 & 0 & 0 \\ 0 & 0 & 0 & 0 & 0 & 0 & 1 & 0 \\ 0 & 0 & 0 & 0 & 0 & 0 & 0 & 1 \end{bmatrix}$$

Example. Boundary conditions for 2D problem. FE model with two 3-node triangles

$$\{q\} = [C] \cdot \{q\}$$

$$\begin{matrix} 8 \times 1 & 8 \times 5 & 5 \times 1 \\ \downarrow & & \end{matrix}$$

$$V = U - W = \frac{1}{2} \cdot [q] \cdot [K] \cdot \{q\} - [q] \cdot \{F\}$$

$$\begin{matrix} 1 \times 8 & 8 \times 8 & 8 \times 1 & 1 \times 8 & 8 \times 1 \\ \leftarrow & & & \uparrow & \end{matrix}$$

$$[q] = [q] \cdot [C]^T$$

$$\begin{matrix} 1 \times 8 & 1 \times 5 & 5 \times 8 \end{matrix}$$

$$V = \frac{1}{2} \cdot [q] \cdot [C]^T \cdot [K] \cdot [C] \cdot \{q\} - [q] \cdot [C]^T \cdot \{F\}$$

$$\begin{matrix} 1 \times 5 & 5 \times 8 & 8 \times 8 & 8 \times 5 & 5 \times 1 & 1 \times 5 & 5 \times 8 & 8 \times 1 \\ \underbrace{\hspace{10em}} & & & & & \underbrace{\hspace{10em}} & & \end{matrix}$$

$$[K] = \begin{bmatrix} l_1+a_2 & n_1+c_2 & o_1+d_2 & e_2 & f_2 \\ n_1+c_2 & t_1+l_2 & u_1+m_2 & n_2 & o_2 \\ o_1+d_2 & u_1+m_2 & w_1+p_2 & r_2 & s_2 \\ e_2 & n_2 & r_2 & t_2 & u_2 \\ f_2 & o_2 & s_2 & u_2 & w_2 \end{bmatrix}$$

$$; \quad \{F\} = \begin{Bmatrix} F_3 \\ F_5 \\ F_6 \\ F_7 \\ F_8 \end{Bmatrix}$$

Example. Boundary conditions for 2D problem. FE model with two 3-node triangles

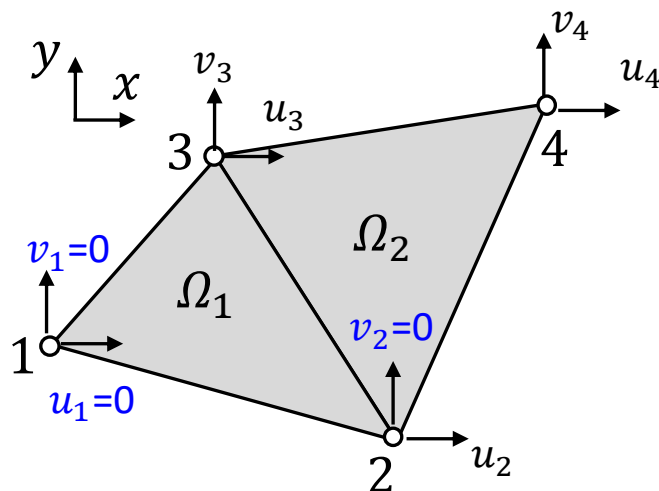

$$[K]_{8 \times 8} \cdot \{q\}_{8 \times 1} = \{F\}_{8 \times 1}$$

	1	2	3	4	5	6	7	8
1	a_1	b_1	c_1	d_1	e_1	f_1	0	0
2	b_1	g_1	h_1	i_1	j_1	k_1	0	0
3	c_1	h_1	l_1+a_2	m_1+b_2	n_1+c_2	o_1+d_2	e_2	f_2
4	d_1	i_1	m_1+b_2	p_1+g_2	r_1+h_2	s_1+i_2	j_2	k_2
5	e_1	j_1	n_1+c_2	r_1+h_2	t_1+l_2	\bar{u}_1+m_2	n_2	o_2
6	f_1	k_1	o_1+d_2	t_1+l_2	\bar{u}_1+m_2	\bar{w}_1+p_2	r_2	s_2
7	0	0	e_2	j_2	n_2	r_2	t_2	\bar{u}_2
8	0	0	f_2	k_2	o_2	s_2	\bar{u}_2	\bar{w}_2

$$\begin{Bmatrix} u_1 = 0 \\ v_1 = 0 \\ u_2 \\ v_2 = 0 \\ u_3 \\ v_3 \\ u_4 \\ v_4 \end{Bmatrix} = \begin{Bmatrix} F_1 \\ F_2 \\ F_3 \\ F_4 \\ F_5 \\ F_6 \\ F_7 \\ F_8 \end{Bmatrix}$$

Example. Boundary conditions for 2D problem. FE model with two 3-node triangles

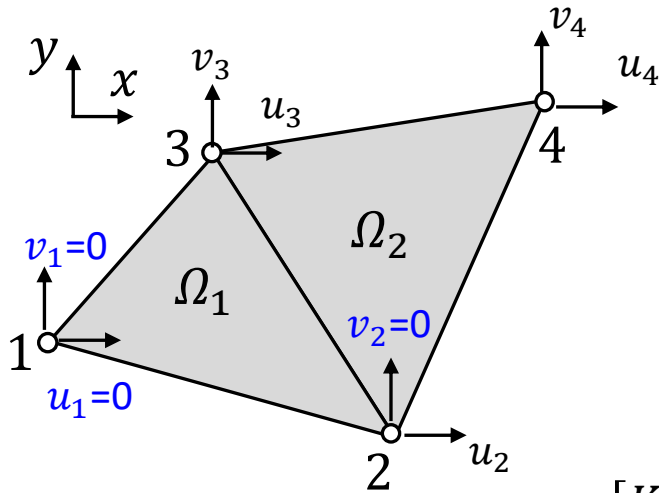

$$N = 8 - 3 = 5$$

$$[K]_{5 \times 5} \cdot \{q\}_{5 \times 1} = \{F\}_{5 \times 1}$$

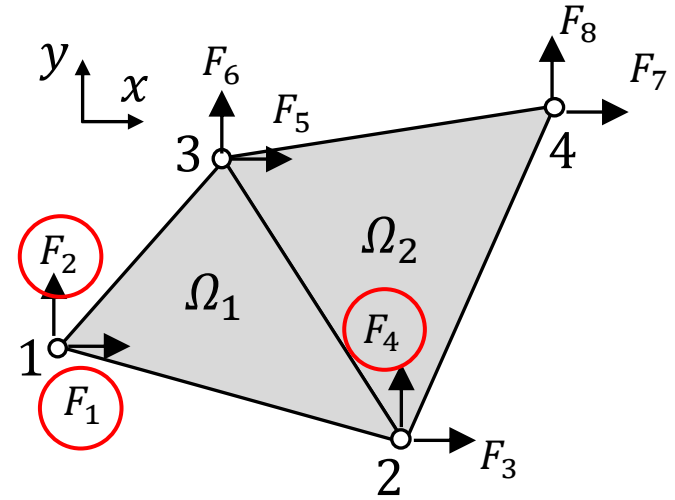

$l_1 + a_2$	$n_1 + c_2$	$o_1 + d_2$	e_2	f_2
$n_1 + c_2$	$t_1 + l_2$	$u_1 + m_2$	n_2	o_2
$o_1 + d_2$	$u_1 + m_2$	$w_1 + p_2$	r_2	s_2
e_2	n_2	r_2	t_2	\bar{u}_2
f_2	o_2	s_2	\bar{u}_2	\bar{w}_2

$$\begin{Bmatrix} u_2 \\ u_3 \\ v_3 \\ u_4 \\ v_4 \end{Bmatrix} = \begin{Bmatrix} F_3 \\ F_5 \\ F_6 \\ F_7 \\ F_8 \end{Bmatrix}$$

set of algebraic equations after considering boundary conditions

Solution of a set of FE equations with boundary conditions

$$\begin{matrix} [K] & \cdot & \{q\} & = & \{F\} & \rightarrow & \det ([K]) \neq 0 & \rightarrow & \{q\} & = & [K]^{-1} & \{F\} \\ N \times N & & N \times 1 & & N \times 1 & & N \times N & & N \times 1 & & N \times N & N \times 1 \end{matrix}$$

DOF solution: $\begin{matrix} \{q\} \\ NDOF \times 1 \end{matrix}$

Element solution (ES): $\begin{matrix} \{\varepsilon\} = [B]\{q\}_e & ; & \{\sigma\} = [D]\{\varepsilon\} = [D][B]\{q\}_e \\ 6 \times 1 & 6 \times n_e \quad n_e \times 1 & 6 \times 1 & 6 \times 6 & 6 \times 1 & 6 \times 6 & 6 \times n_e & n_e \times 1 \end{matrix}$

\uparrow strain in a finite element \uparrow stress in a finite element

Nodal solution (NS):

$$(NS)_i = \frac{\sum_{e=1}^k (ES)_{ei}}{k}$$

$(NS)_i$ – averaged nodal solution at node (i)

$(ES)_{ei}$ – element solution in element (e) and at node (i)

k – no. of elements adjacent to node (i)

Example. DOF solution $u(x,y)$ for 2D problem. FE model with 4-node quadrilateral elements

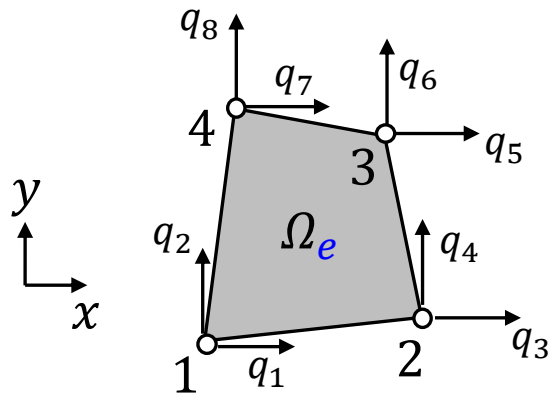

$$\{u\} = [N]\{q\}_e$$

2×1 2×8 8×1

$u_e(x,y)$ – displacement in x direction

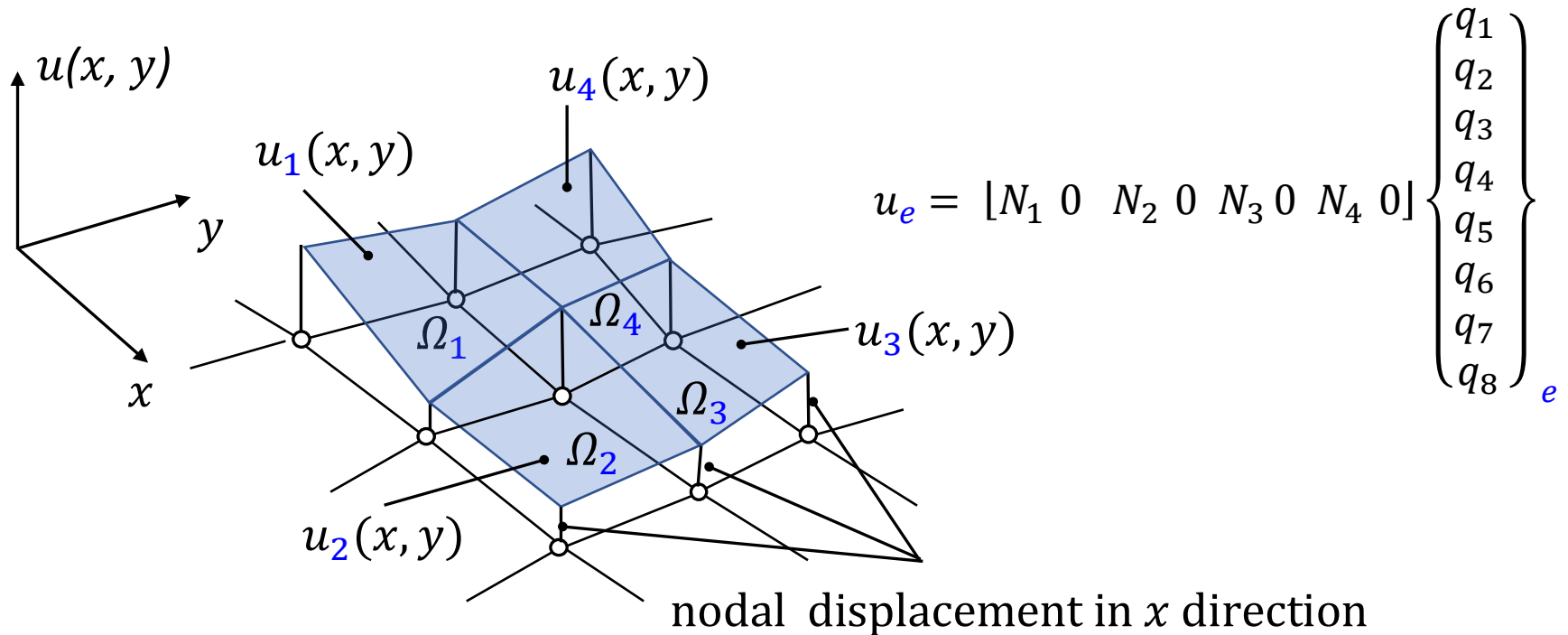

Example. Strain component $\varepsilon_y(x, y)$ for 2D problem. FE model with 4-node quadrilateral elements

Element solution:

Nodal solution:

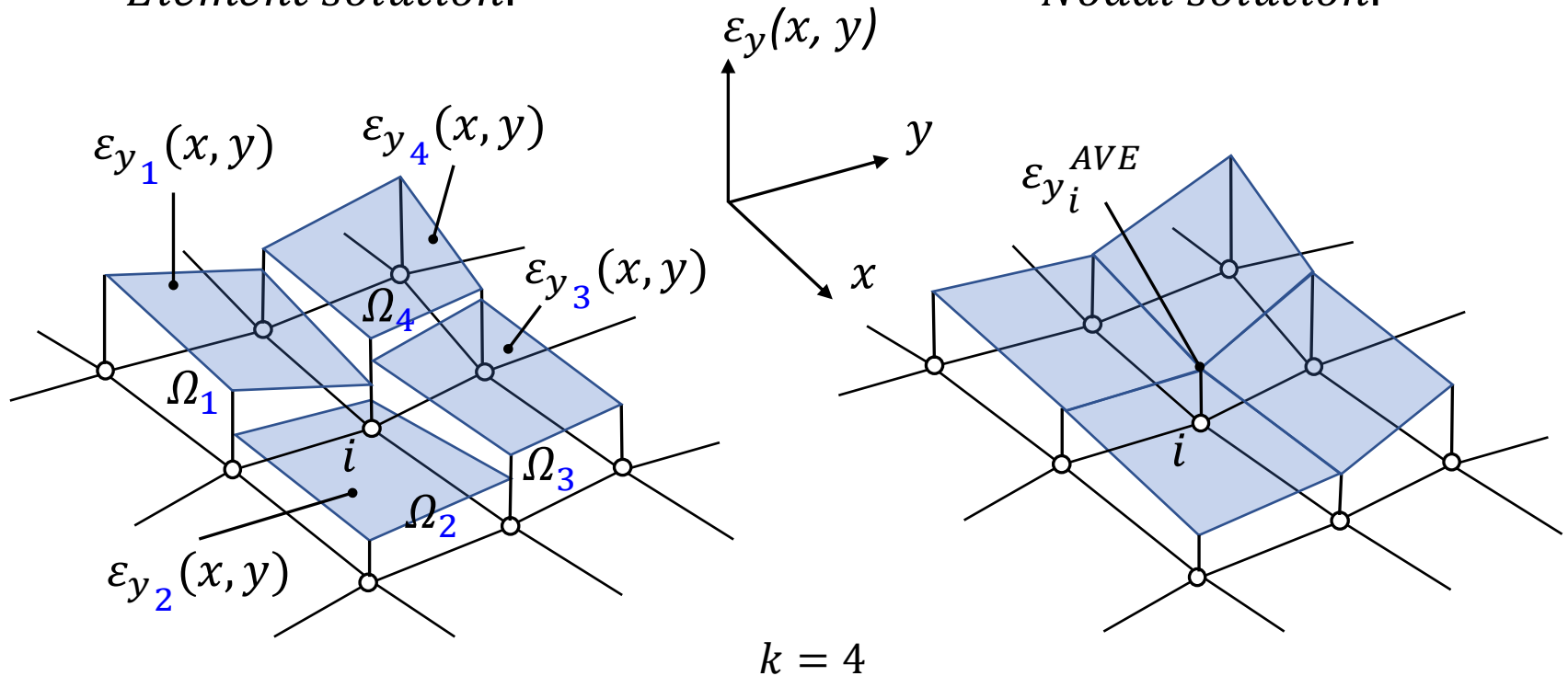

$$\varepsilon_{y_i}^{AVE} = \frac{\varepsilon_{y_1}(x_i, y_i) + \varepsilon_{y_2}(x_i, y_i) + \varepsilon_{y_3}(x_i, y_i) + \varepsilon_{y_4}(x_i, y_i)}{4}$$

Example. Reactions calculation for 2D problem. FE model with two 3-node triangles

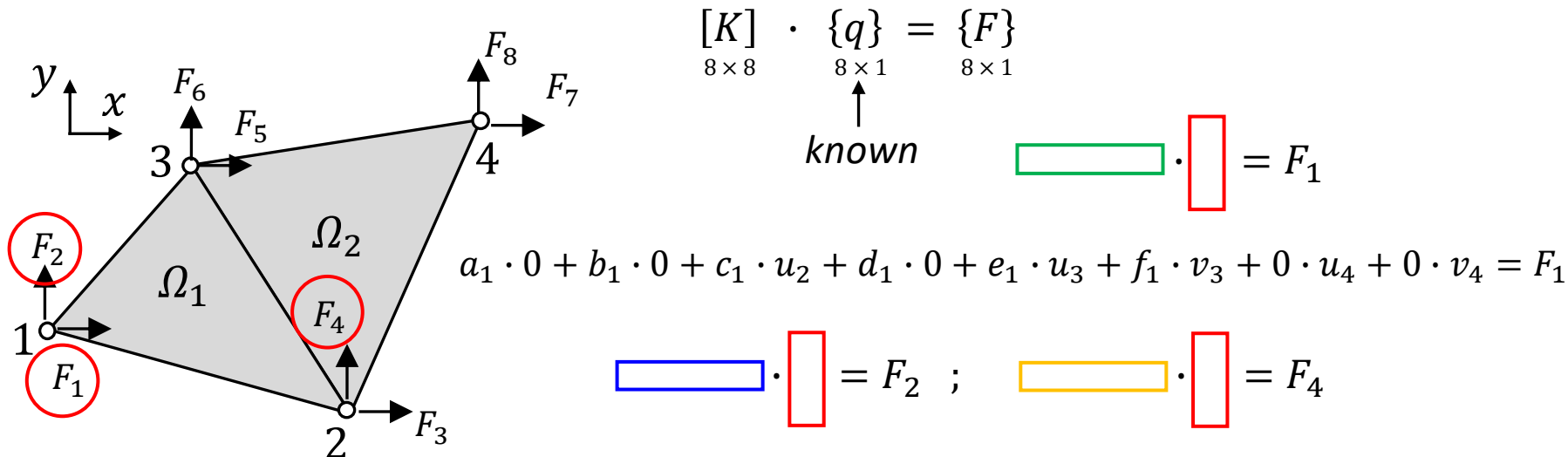

	1	2	3	4	5	6	7	8
1	a_1	b_1	c_1	d_1	e_1	f_1	0	0
2	b_1	g_1	h_1	i_1	j_1	k_1	0	0
3	c_1	h_1	$l_1 + a_2$	$m_1 + b_2$	$n_1 + c_2$	$o_1 + d_2$	e_2	f_2
4	d_1	i_1	$m_1 + b_2$	$p_1 + g_2$	$r_1 + h_2$	$s_1 + i_2$	j_2	k_2
5	e_1	j_1	$n_1 + c_2$	$r_1 + h_2$	$t_1 + l_2$	$\bar{u}_1 + m_2$	n_2	o_2
6	f_1	k_1	$o_1 + d_2$	$t_1 + l_2$	$\bar{u}_1 + m_2$	$\bar{w}_1 + p_2$	r_2	s_2
7	0	0	e_2	j_2	n_2	r_2	t_2	\bar{u}_2
8	0	0	f_2	k_2	o_2	s_2	\bar{u}_2	\bar{w}_2

$$\begin{Bmatrix} u_1 = 0 \\ v_1 = 0 \\ u_2 \\ v_2 = 0 \\ u_3 \\ v_3 \\ u_4 \\ v_4 \end{Bmatrix} = \begin{Bmatrix} F_1 \\ F_2 \\ F_3 \\ F_4 \\ F_5 \\ F_6 \\ F_7 \\ F_8 \end{Bmatrix}$$